

# Signet 2551 Display Magmeter



3-2551.090-1 Rev. N 04/16

## Operating Instructions



- [English](#)
- [Deutsch](#)
- [Français](#)
- [Español](#)
- [Italiano](#)
- [Português](#)



### Description

The 2551 Magmeter measures the flow rate in a full pipe by monitoring the voltage produced when the (conductive) fluid moves through a magnetic field. Output options include a traditional frequency signal, a serial data (Digital (S<sup>3</sup>L)) output, and a 4 to 20 mA output.

The 2551 Magmeter is available in three sizes that will accommodate pipes from ½ inch through 36 inch diameters.

Select from three different material combinations to match the Magmeter to the application requirements.

### Table of Contents

Warranty Information .....	2
Product Registration .....	2
Safety Information .....	2
Chemical Compatibility .....	2
Dimensions .....	2
Specifications .....	3
Installation .....	4
Pipe Fittings .....	4
Selecting a Location.....	4
Overview Magmeter Display.....	5
Wiring .....	5
Mirror Relay 1 Output.....	5
Frequency Output .....	5
4 to 20 mA Output.....	6
Wiring to other Manufacturer's Instruments .....	6
Wiring to Signet Flow Instruments .....	6
Wiring Relays.....	7
Application Notes: Relay Wiring.....	7
Navigating the Menus.....	8
Keypad Functions .....	8
Security Code .....	8
View Menu.....	9
Resetting the Resettable Totalizer .....	9
Setup Menu .....	10
Averaging and Sensitivity.....	11
Bi-Directional Flow.....	12
Calibration Data: K-Factors.....	12-13
Calibration Menu.....	14
Volume Method of Calibration.....	14
Rate Method of Calibration .....	14
Relay Menus.....	15
Pulse Relay Mode.....	15
Total Relay Mode .....	15
High, Low, or Window Relay Modes .....	16
Test Menu .....	17
Options Menu .....	17
Output Modes .....	17
Grounding.....	18
Maintenance.....	18
Troubleshooting.....	19
Ordering Information.....	20

## Warranty Information

Refer to your local Georg Fischer Sales office for the most current warranty statement.

All warranty and non-warranty repairs being returned must include a fully completed Service Form and goods must be returned to your local GF Sales office or distributor. Product returned without a Service Form may not be warranty replaced or repaired.

Signet products with limited shelf-life (e.g. pH, ORP, chlorine electrodes, calibration solutions; e.g. pH buffers, turbidity standards or other solutions) are warranted out of box but not warranted against any damage, due to process or application failures (e.g. high temperature, chemical poisoning, dry-out) or mishandling (e.g. broken glass, damaged membrane, freezing and/or extreme temperatures).

## Product Registration







Thank you for purchasing the Signet line of Georg Fischer measurement products.

If you would like to register your product(s), you can now register online in one of the following ways:

- Visit our website [www.gfsignet.com](http://www.gfsignet.com). Under **Service and Support** click on **Product Registration Form**
- If this is a pdf manual (digital copy), [click here](#)

## Safety Information

1. Depressurize and vent system prior to installation or removal.
2. Confirm chemical compatibility before use.
3. Do not exceed maximum temperature / pressure specifications.
4. Wear safety goggles or faceshield during installation/service.
5. Do not alter product construction.

	<b>Caution / Warning / Danger</b> Indicates a potential hazard. Failure to follow all warnings may lead to equipment damage, injury, or death
	<b>Electrostatic Discharge (ESD) / Electrocutation Danger</b> Alerts user to risk of potential damage to product by ESD, and/or risk of potential of injury or death via electrocution.
	<b>Personal Protective Equipment (PPE)</b> Always utilize the most appropriate PPE during installation and service of Signet products.
	<b>Pressurized System Warning</b> Sensor may be under pressure, take caution to vent system prior to installation or removal. Failure to do so may result in equipment damage and/or serious injury.
	<b>Hand Tighten Only</b> Overtightening may permanently damage product threads and lead to failure of the retaining nut.
	<b>Do Not Use Tools</b> Use of tool(s) may damage product beyond repair and potentially void product warranty.
	<b>Note / Technical Notes</b> Highlights additional information or detailed procedure.

## Chemical Compatibility

The retaining nuts of Magmeters are not designed for prolonged contact with aggressive substances. Strong acids, caustic substances and solvents or their vapor may lead to failure of the retaining nut, ejection of the sensor and loss of the process fluid with possibly serious consequences, such as damage to equipment and serious personal injury. Retaining nuts that may have been in contact with such substances e.g. due to leakage or spilling, must be replaced.

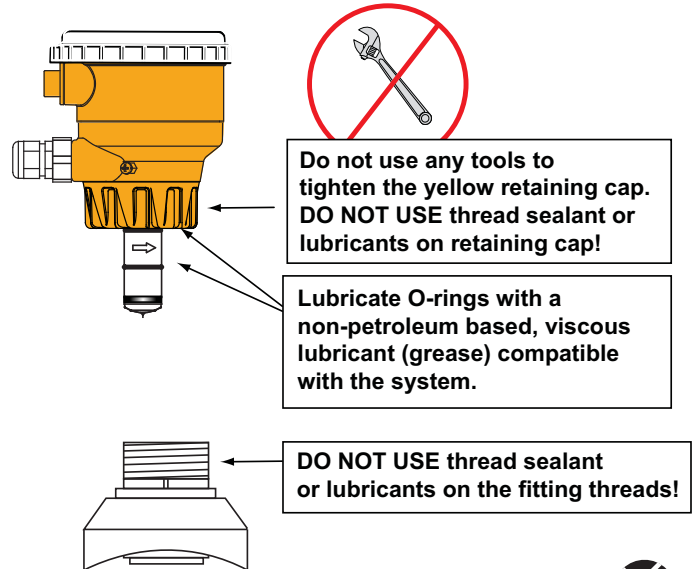

**Failure to follow these instructions may result in the sensor being ejected from the pipe!**

If leaking is observed from the retaining cap, it indicates defective or worn o-rings on the sensor. Do not attempt to correct by further tightening.

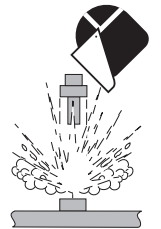

## Dimensions

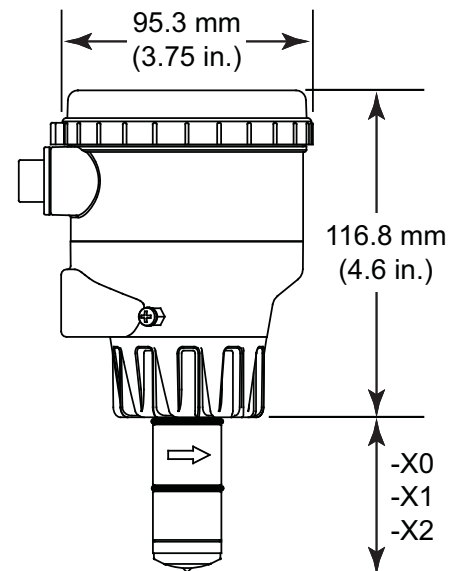

Pipe Range	Insertion Depth
½ in. to 4 in.	-X0 = 58 mm (2.3 in.)
5 in. to 8 in.	-X1 = 91 mm (3.6 in.)
10 in. to 36 in.	-X2 = 167 mm (6.6 in.)

X = Sensor Body Material (P, T, or V)

## Specifications

### General

Pipe size range.....DN15 to DN900 (½ in. to 36 in.)  
 Flow Range .....Minimum: 0.05 ms (0.15 ft/s)  
 (Bi-directional) .....Maximum: 10 ms (33 ft/s)  
 Linearity .....±1% of reading +0.01 ms (0.033 ft/s)  
 Repeatability .....±0.5% of reading @ 25 °C (77 °F)  
 Minimum Conductivity ...20 µS/cm

### Wetted Materials

Sensor body and Electrodes and Grounding ring:  
 -P0, -P1, -P2 .....Polypropylene and 316L SS  
 -T0, -T1, -T2 .....PVDF and Titanium  
 -V0, -V1, -V2 .....PVDF and Hastelloy-C  
 O-rings .....FPM (standard) EPDM, FFPM  
 (optional)



The user is responsible for determining the chemical suitability of these materials for a specific application.

### Power Requirements

4 to 20 mA .....21.6 to 26.4 VDC, 22.1 mA max.  
 400 mV p-p maximum ripple voltage  
 Frequency .....5 to 26.4 VDC, 15 mA max.  
 Digital .....5 to 6.5 VDC, 15 mA max.  
 Auxiliary .....9 to 24 VDC, 0.4A max  
 (only required for units with relays)  
 Reverse polarity and short circuit protected

### Current output (4 to 20 mA)

Max Loop Resistance ...300 Ω  
 Loop Accuracy .....32 µA max. error (25 °C @ 24 VDC)  
 Temp. drift .....± 1 µA per °C max.  
 Power supply rejection ...± 1 µA per V  
 Isolation: .....Low voltage < 48 VAC/DC from  
 electrodes and aux power  
 Maximum cable .....300 m (1000 ft)  
 Error condition .....22.1 mA

### Frequency output

Output modes .....Freq, Freq±10, or Mirror Relay 1  
 Max. Pullup Voltage .....30 VDC  
 Max. Current Sink .....50 mA, current limited  
 Maximum cable .....300 m (1000 ft)  
 Reverse Polarity Protected to -40 V

### Digital (S<sup>3</sup>L) Output

Serial ASCII, TTL level 9600 bps  
 Compatible with Signet 8900 and 9900  
 Maximum cable .....Application dependent (See 8900 manual)

### Relay Specifications

Relay 1 and 2 Type .....Mechanical SPDT  
 Rating .....5 A @ 30 VDC max.,  
 5 A @ 250 VAC max.  
 Relay 3 Type .....Solid State  
 Rating .....50 mA @ 30 VDC, 50 mA @ 42 VAC  
 Hysteresis .....Adjustable, plus timer delay  
 Trigger Delay .....Adjustable (0 to 9999.9 sec.)  
 Relay Modes .....Off, Low, High, Window, and  
 Proportional Pulse  
 Relay Source .....Flow Rate, Resettable Totalizer  
 Error Condition .....Selectable; Fail Open or Fail Closed

### Display

Characters .....2 x 16  
 Contrast .....User-set in four levels  
 Backlighting .....Requires external 9-24 VDC,  
 0.4 mA max. (only on relay versions)

### Environmental Requirements

Enclosure .....NEMA 4X / IP65 (with cap installed)  
 Case .....PBT  
 Display window .....Polyamide  
 Storage Temperature .....-20 °C to 70 °C (-4 °F to 158 °F)  
 Relative Humidity .....0 to 95% (non-condensing)  
 Operating Temperature:  
 Ambient .....-10 °C to 70 °C (14 °F to 158 °F)  
 Media .....0 °C to 85 °C (32 °F to 185 °F)  
 Operating pressure:  
 Maximum .....10.3 bar @ 25 °C (150 psi @ 77 °F)  
 1.4 bar @ 85 °C (20 psi @ 185 °F)

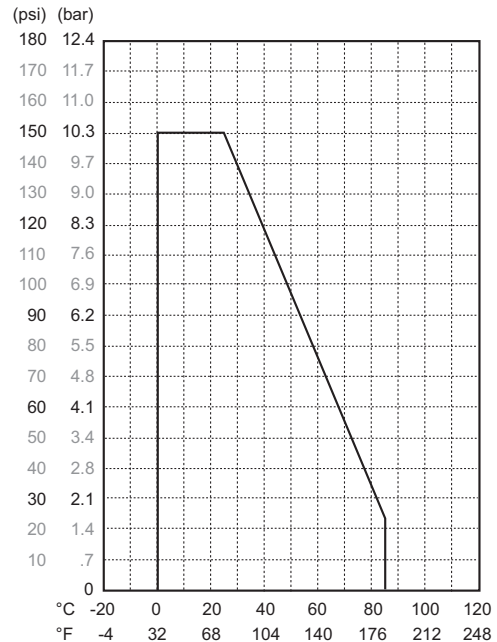

### Standards and Approvals

- CE
- UL/CUL (for display versions with relays)
- NSF (3-2551-P versions only)
- RoHS compliant
- China RoHS (visit [gfsignet.com](http://gfsignet.com) for details)
- Manufactured under ISO 9001 for Quality, ISO 14001 for Environmental Management and OHSAS 18001 for Occupational Health and Safety.







### FC Declaration of Conformity according to FCC Part 15

This device complies with Part 15 of the FCC rules. Operation is subject to the following two conditions:  
 (1) This device may not cause harmful interference, and,  
 (2) This device must accept any interference received, including interference that may cause undesired operation.

## Installation

### Pipe fittings

Georg Fischer offers a wide selection of installation fittings that control the position of the Magmeter electrodes in relation to the dimensions of the pipe. You will find a complete list of order numbers for installation fittings in the Calibration Tables on pages 8, 9.

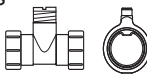
Type	Description
 <p>Plastic tees</p>	<ul style="list-style-type: none"> <li>• 0.5 in. to 2 in. versions</li> <li>• MPVC or CPVC</li> </ul>
 <p>PVC Glue-on Saddles</p>	<ul style="list-style-type: none"> <li>• 10 in. and 12 in. only</li> <li>• Cut 2½ in. hole in pipe</li> <li>• Weld in place using solvent cement</li> </ul>
 <p>PVC Clamp-on Saddles</p>	<ul style="list-style-type: none"> <li>• 2 in. to 4 in., cut 1-7/16 inch hole in pipe</li> <li>• 6 in. to 8 in., cut 2-1/8 in. hole in pipe</li> </ul>
 <p>Iron Strap-on saddles</p>	<ul style="list-style-type: none"> <li>• 2 in. to 4 in., cut 1-7/16 inch hole in pipe</li> <li>• Over 4 inch, cut 2-1/8 inch hole in pipe</li> <li>• Special order 14 in. to 36 in.</li> </ul>
 <p>Iron, Carbon Steel &amp; 316 Stainless Steel Threaded Tees</p>	<ul style="list-style-type: none"> <li>• 0.5 in. to 2 in. versions</li> <li>• Mounts on Threaded pipe ends</li> </ul>
 <p>Carbon steel &amp; Stainless Steel Weld-on Weldolets</p>	<ul style="list-style-type: none"> <li>• 2 in. to 4 in., cut 1-7/16 inch hole in pipe</li> <li>• Over 4 inch, cut 2-1/8 inch hole in pipe</li> </ul>
 <p>Fiberglass Tees FPT</p>	<ul style="list-style-type: none"> <li>• 1.5 in. to 2 in. PVDF insert</li> </ul>
 <p>Union Fittings and Wafers</p>	<ul style="list-style-type: none"> <li>• For pipes from DN 15 mm to 50 mm PP or PVDF</li> </ul>

## Location of Fitting

To ensure the fluid velocity profile is Fully Developed, without distortion from piping system components, please adhere to the recommended straight run geometry.

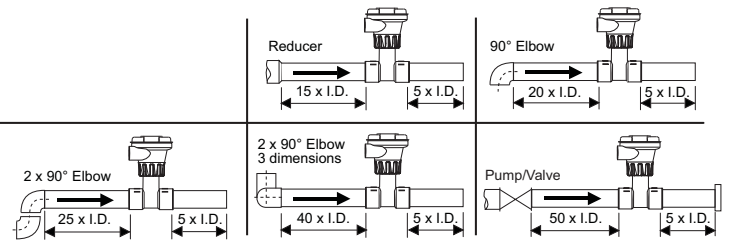

## Sensor Mounting Position

### Horizontal pipe Runs

To minimize adverse effects of air pockets, sediment, or excessive rotor wear (Paddlewheels), avoid mounting the flow sensor at the top of the pipe (0°), bottom of pipe (180°), or the sides (90° from vertical).

### Vertical Pipe Runs

Mount flow sensors in any direction. To ensure pipe is flowing full, with some back pressure, it's highly recommended the fluid flow is upward.

### Gravity and Discharge Lines

It's recommended to install a trap to ensure pipe is full during flow conditions, and to minimize air pockets.

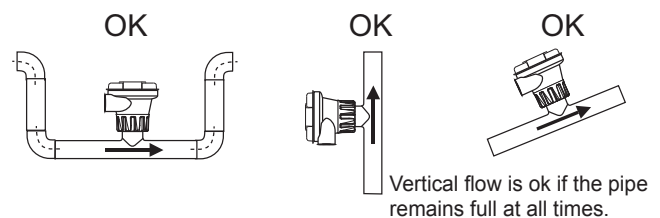
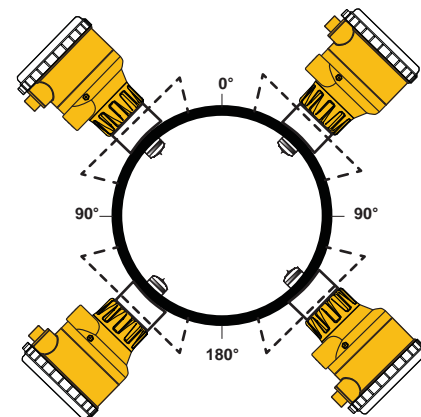

## Overview of Magmeter Display

2551 Display Magmeters use a dual-sided electronics module and dual conduit ports. Unused ports must be sealed to protect the electronics from water damage.

- The lower set of conduit ports provide access to the wiring terminals for:
  - Loop Power
  - Flow Output Signal (current loop, Digital (S<sup>3</sup>L), frequency or Mirror Relay 1 output).
- The upper set of conduit ports provide access to the wiring terminals for:
  - Relay output wiring
  - Auxiliary power for relay coils and display backlight
- The sensor is marked with a directional arrow to indicate the direction identified as forward flow.
  - An adhesive decal is also provided that can be affixed to the pipe to indicate the direction of forward flow.
  - Flow in the opposite direction from the arrow will be identified as reverse flow on the display by a "-" symbol.
- The terminals in the magmeter are designed to accommodate 16 to 22 AWG conductors.
- The display includes two LEDs that light when Relay 1 or Relay 2 are activated.
  - All three relays can be monitored by scrolling to the Relay Status display located in the View menu.
  - If the Language option has not been made, new magmeters will always open with the Select Language display.

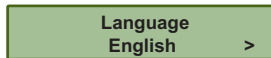

- The part number, serial number and output type are identified on the electronics module.

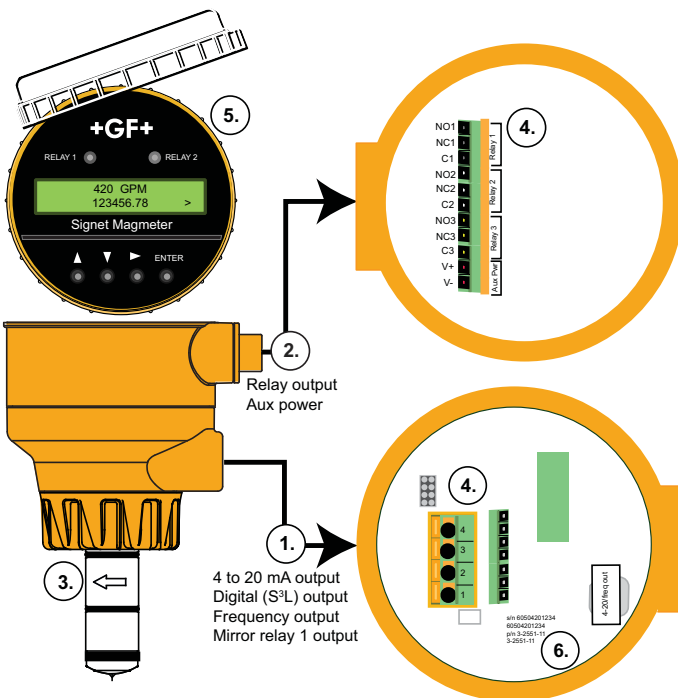

## Wiring to Mirror Relay 1 Output

The 3-2551-21 and 3-2551-41 Magmeter can be configured in the OPTIONS menu to provide an Open Collector output in lieu of the sensor signal provided by Frequency or Digital (S<sup>3</sup>L) output selections. The Open Collector output can be programmed via the Relay 1 menu.

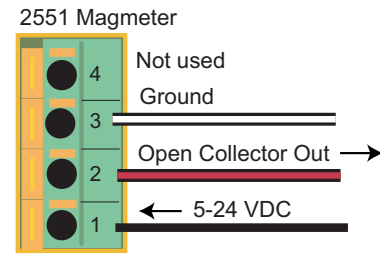

## Wiring to Frequency Output

3-2551-21 and 3-2551-41 Magmeters may be programmed in the OPTIONS menu to provide an open collector FREQUENCY output.

- The maximum frequency output is 1000 Hz (at 10 meters per second)
- If the Frequency ÷ 10 output is selected, the maximum frequency is 100 Hz (at 10 meters per second).
- AUX PWR must be connected to power the display backlighting and to power the relay coils if included.

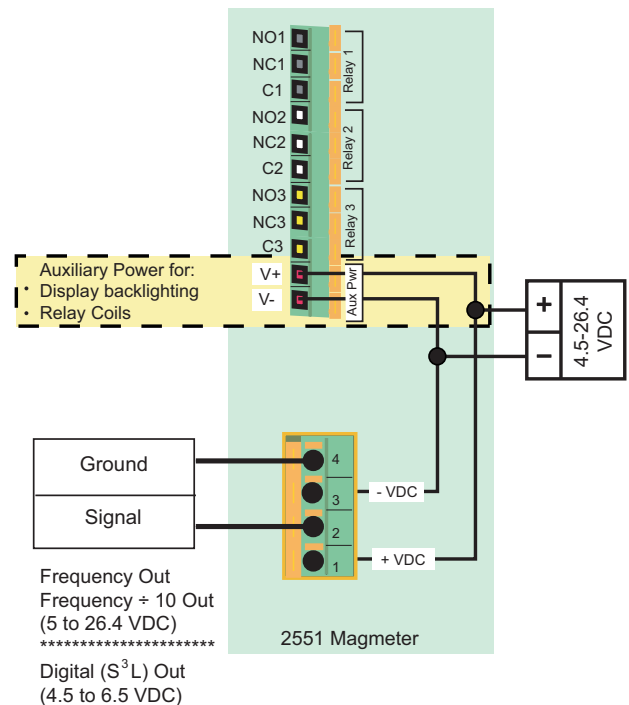



## Wiring to 4 to 20 mA Output

The 3-2551-22 and 3-2551-42 Magmeters provide a passive 4 to 20 mA loop output.

- External loop power (24 VDC) is required.
- Factory standard calibration is 4 to 20 mA = 0 to 5 m/s.
- The 4 to 20 mA output can be spanned to any range, from -10 m/s to +10 m/s.
- AUX PWR must be connected to power the display backlighting and to power the relay coils if included.

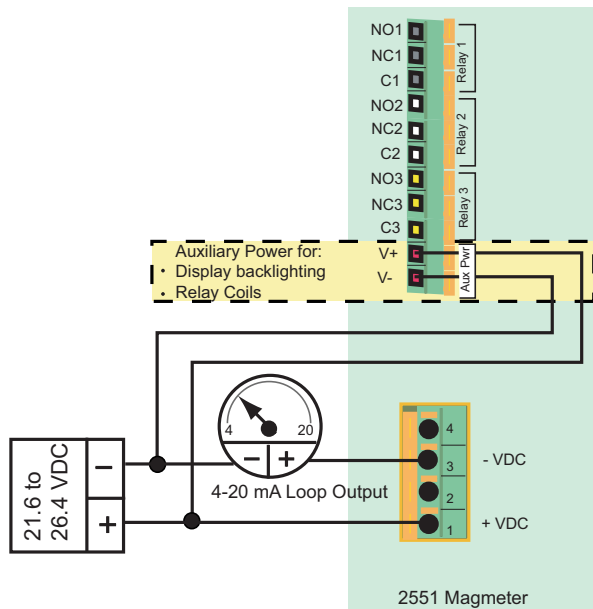

## Wiring to Signet Flow Instruments

The 3-2551-21 and 3-2551-41 Magmeter can be configured in the OPTIONS menu to provide a Frequency or Digital (S<sup>3</sup>L) output.

Frequency and Digital (S<sup>3</sup>L) output can be used by Signet 8900 Multi-Parameter Controller and 9900 Transmitter.

### 2551 Frequency or Digital (S<sup>3</sup>L) Out to 9900 Transmitter

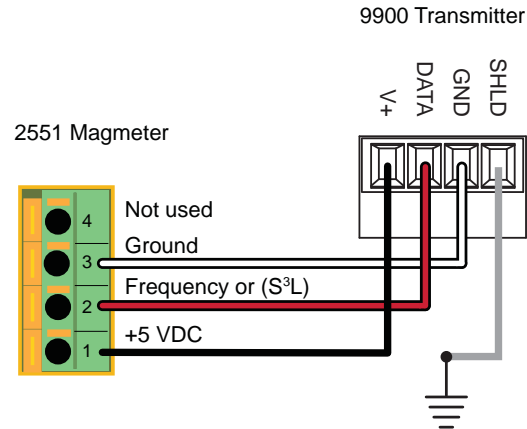

### 2551 Frequency Out to 8900 Controller

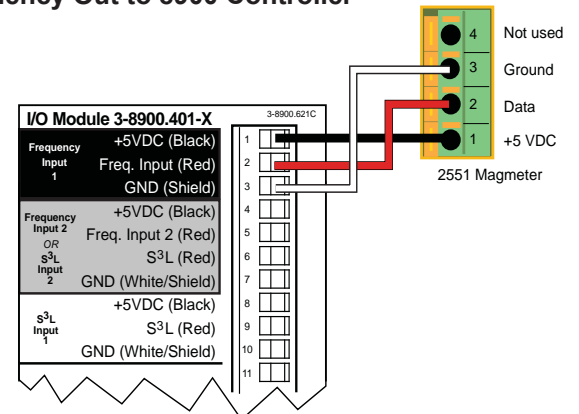

### 2551 Digital (S<sup>3</sup>L) Out to 8900 Controller

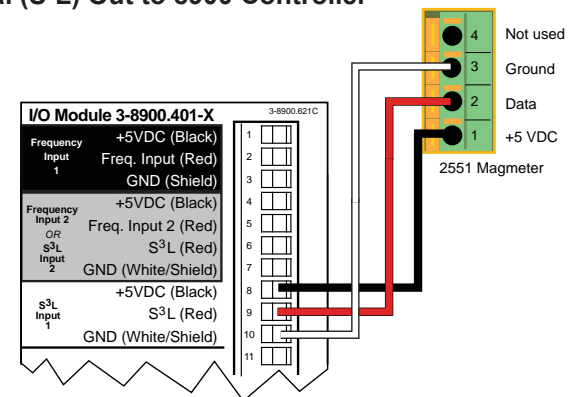

## Wiring to other manufacturer's Instruments

When using the 2551 in a system with other manufacturer's equipment, a 10 K $\Omega$  pull-up resistor (not supplied) may be required to power the open collector output.

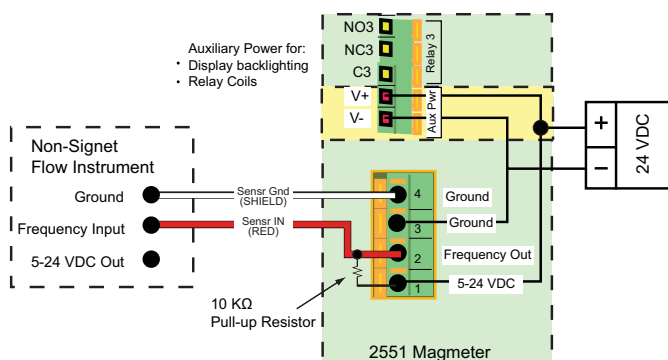

## Wiring Relays

Relay 1, Relay 2 Type: Mechanical SPDT  
 Rating: 5A @ 30 VDC max., 5 A @ 250 VAC max

Relays 1 and 2 are dry contact relays rated for 5 A maximum current. They are best suited for switching high voltage loads, such as AC powered pumps and valves.

When used to switch inductive loads, the dry contact relays may be damaged by arcing. Signet recommends the installation of a filter device to prevent such damage.

3-8050.396    159 000 617    RC Filter kit (for relay use)

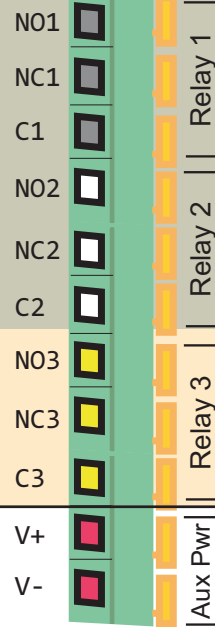

Mechanical Relays:  
 5A @ 250 VAC  
 5A @ 30 VDC

Solid State Relay 3:  
 50 mA max @ 30 VDC  
 50 mA max @ 42 VAC

Auxiliary Power  
 9 to 24 VDC  
 0.4 A Maximum



Auxiliary power must be connected to operate the relays and to power the display backlighting. Auxiliary power is fully isolated. The Loop Power supply may be used for Aux power if the power source provides a sufficient current rating.

### Relay Terminal Legend:

**NO:** Normally Open  
**NC:** Normally Closed  
**C:** Common

### Application Notes: Relay Wiring

- Inductive relay loads may generate transient voltage spikes well in excess of the relay contact ratings. This will cause arcing across the contacts and consequently rapid relay wear. Signet recommends an RC-style filter ("snubber"), installed as illustrated here.
- The filter kit (3-8050.396) is available as an accessory item. See ordering information on back cover.
- Signet product warranty does not cover damage to relays due to contact burnout.

#### Definition:

An **inductive load** is an electrical device generally made of wire that is coiled to create a magnetic field to produce mechanical work when energized.

Examples of inductive loads include motors, solenoids, and relays.

High voltage transients from these types of loads can cause arcing across mechanical switching contacts or can cause damage to solid-state contacts.

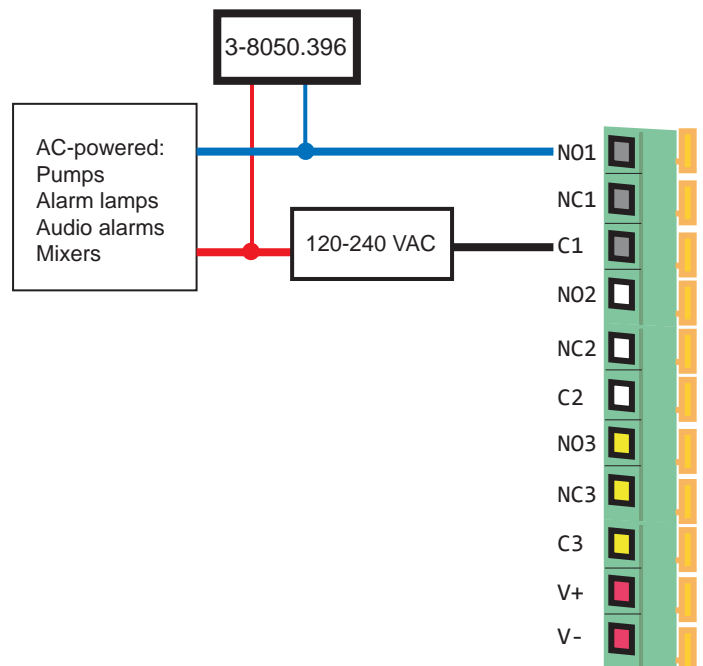

## Navigating the Menus

### Normal Operation Display

The normal operating display shows the Flow Rate on the top line and the Resettable Totalizer on the bottom line.

- All menu instructions in this manual assume that the instrument is showing this display.

### 2551 Menu Directory

The 2551 Magmeter uses seven main menus to provide access to the calibration and programming features. Each menu serves a specific function.

Starting from the normal operating display, there are two ways to access the menus:

- Press the ▲ key to scroll to the Enter Menu display, then press the ► key.
- Press the ENTER key and hold it for about three seconds.

### Setup Menu

This menu contains all of the settings and information that the magmeter requires to operate, including the K-Factor, the totalizer settings, low flow cutoff, and several display characteristics. See page 10 for details related to this menu.

### Calibration Menu

This menu provides two different methods for adjusting the calibration. See page 14 for details related to this menu.

### Relay Menus

Each of the available relays in the 3-2551-21 and 3-2551-22 are programmed from their own dedicated menu. See page 15 for details related to these menus.

**NO** Menu items associated with Relays 2 and 3 are suppressed in models without relays.

### Test Menu

This menu is used to manually toggle relays or to induce a known value out of the 4 to 20 mA terminals. See page 17 for details related to this menu.

### Options Menu

This menu contains those settings and values that are usually programmed during the initial installation, and then seldom modified, including the SECURITY CODE (see section below). See page 17 for details related to the Options menu.

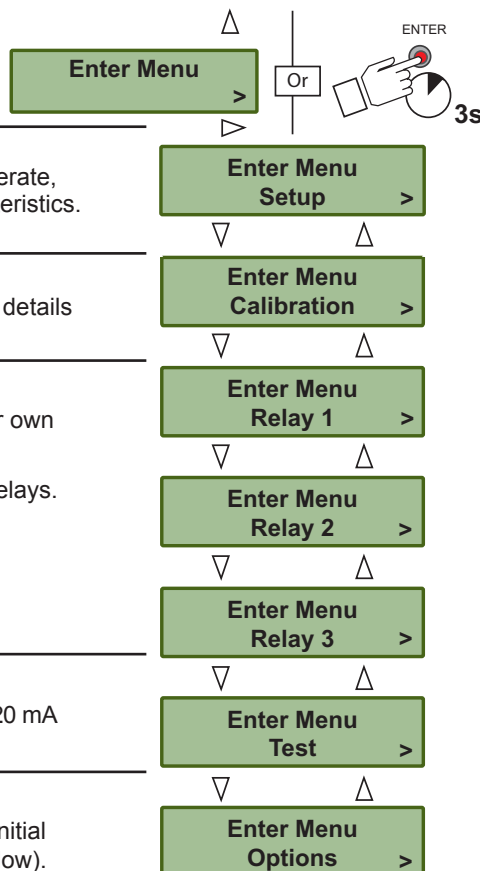

## Keypad Functions

▲	Scrolls UP through any menu. If the display shows any flashing character or selection, scrolls UP to the previous value or selection.
▼	Scrolls DOWN through any menu. If the display shows any flashing character or selection, scrolls DOWN to the next value or selection.
▲▼	Press the ▲ and ▼ keys together to abandon any unsaved edits and return to the previous display.
►	Opens the menu currently being displayed. In Edit modes, advances the flashing character. In menus with only two options (Yes or No, On or Off) toggles between selections.
ENTER	Saves a new selection in any menu. From Normal Operation display, jumps to first selection in Menu directory (when held for three seconds)

## Security Code

The 2551 has a security code that can be programmed to any four-digit numerical value.

- The factory setting is 0-0-0-0.
- To program the security code go to the Options menu.
- The security code will be required to edit any of the items in the menus. It is required only once for each editing session.
- Record the custom security code here or in a safe location.
- If the security code is lost, contact your Signet service center for instructions.





## View Menu

The VIEW menu contains all of the basic information available from the Magmeter.

- The normal operating display shows the FLOW RATE on the top line of the display and the Resettable Totalizer on the lower line of the display.
- The Right Prompt symbol (>) always indicates a sub-menu associated with the current display. In this display it points the way to the TOTALIZER RESET function. See below for detailed instructions.
- With AUXILIARY power connected to the magmeters with Relays, the display will be backlit. There is no switch to turn the backlight off.
-  A flashing character or text on the display indicates that the item is being edited. This manual uses a (red) star to illustrate a flashing display.
- The following information is viewed by scrolling ▲ or ▼. These displays will remain in the display for 10 minutes, then the normal operating display will return.

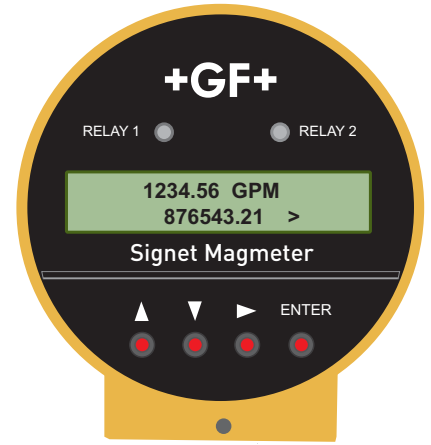

Show the permanent total. This totalizer cannot be reset.

Shows the current output. For 4 to 20 mA Output models only.

Relay States shown for units with a relay board.

This display is a reminder to visit the Signet website for updates and information about Signet products.

Enter menus from this display. See page 10 for details.

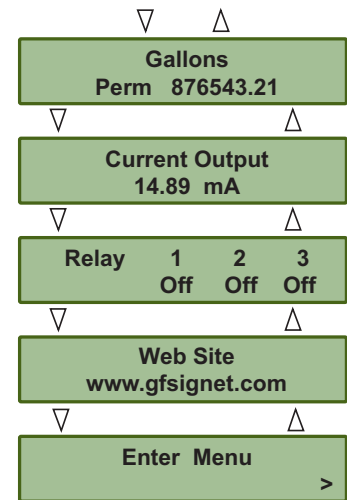

## Resetting the Resettable Totalizer

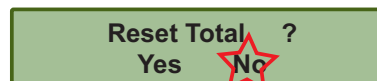
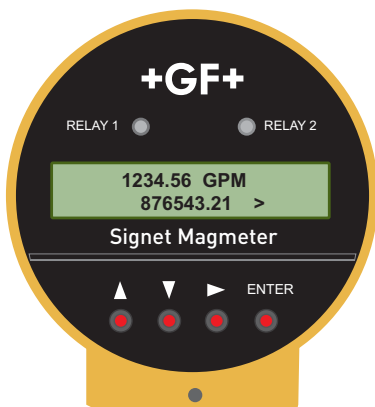

1. From the normal operating display, press the ► key.
2. The resettable totalizer can be configured to require the security code before allowing the reset. If the Total Reset is set to "RESET OFF" this display will not appear. See page 17, Options Menu for instructions.
3. Press any arrow key to toggle the flashing selection from NO to YES.
4. Press the ENTER key. The totalizer will reset to all zeroes and the display will immediately return to the normal operating display.

## Setup enu

The Setup menu contains all of the parameters necessary for the 2551 Magmeter to begin measuring flow.

**NOTE:** The Security Code must be entered before any changes can be made to the Setup menu. See page 17 for details related to the Options menu..

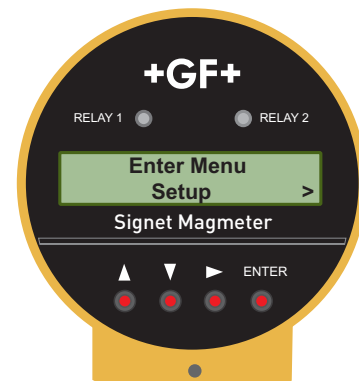

Use the keypad to navigate through each setting.

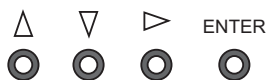

The values shown for each menu item represent the factory standard setting. All 2551 magmeters are packaged with these settings.

**K-Factor:** See the charts on pages 12-13 for values in pulses per U.S. gallon or in pulses per liter. To use other units, convert the published values as appropriate.



**Pipe Size:** Select the pipe size that is nearest to the nominal pipe size.

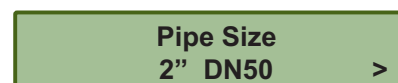

**Flow Units:** Set the units for the application. Four characters are available. The first three characters can be set to any symbol or alpha character, upper or lower case. The following special symbols are located between the upper case and lower case menus:

- (centered dot)       $\mu$  (micro)      \_ (blank)
- (dash)              / (slash)              3 (for cubic units)

The last character selects the timebase for the flow rate measurement. Select S/s (seconds) M/m (minutes), H/h (hours) or D/d (days)



**Set 4 mA:** (2551-22 and -42 versions only) Set the flow rate where the current output will be 4 mA.



**Set 20 mA:** (2551-22 and -42 versions only) Set the flow rate where the current output will be 20 mA.

The 4 to 20 mA output may be spanned to monitor forward and reverse flow rates.



**Total Factor:** Set the factor by which the totalizer will count. This setting is made in the application units (i.e., gallons, liters, etc.)

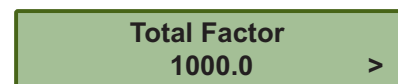

**Totalizer Units:** Set the Totalizer Units. This setting serves as a label for the totalizer displays only. It has no effect on the measurement. The special characters listed in the Total Factor settings are available here also.

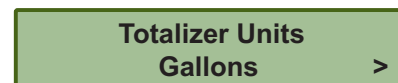

**Low Flow Cutoff:** Set a flow rate that the 2551 Magmeter will use as a minimum threshold. If the flow rate falls below this value, the 2551 will respond as if the flow were zero.

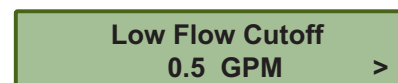

**Averaging:** Set the averaging period based on the installation and flow conditions. Smaller values allow the 2551 to respond to changes in flow rate quickly, while larger values smooth the fluctuations caused by installation and flow conditions. See page 11 for details.



**Sensitivity:** Set a percentage of maximum range by which the flow must change to override the averaging feature and "jump" quickly to the new flow rate. See detailed explanation on page 11.

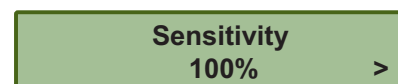

## Averaging and Sensitivity

Even the most carefully engineered flow systems may experience erratic and unstable conditions. If the instability is communicated to the output functions, the results may create problems for control devices.

To alleviate these issues, the 2551 provides two adjustments that operate in tandem. The information here will help in determining the appropriate settings for any specific application.

### Averaging

- The AVERAGING setting dictates the time over which the magmeter will average the flow signal.

The LCD display is updated every second. With averaging at 14 seconds, the flow rate on the display is an average of the previous 14 seconds input.

Short averaging times provide the fastest display and output response to changes in the flow rate.

Higher averaging times help to smooth the display and current output where the flow in the pipe is erratic or unstable due to installation limitations.

### Sensitivity

- The SENSITIVITY setting determines how the 2551 responds to sudden surges in the flow rate. It "overrides" the Averaging function just long enough to allow an actual change in flow rate to be displayed, then resumes the averaging. The result is a smooth flow display and a quick response to large shifts in the flow rate.

The settings for Sensitivity represent a percentage of the magmeter's maximum range, or 10 milliseconds (ms).

Example: A sensitivity setting of 25% means that the flow rate must change instantly and by more than 2.5 ms before the function is enabled.

**NOTE:** The SENSITIVITY function is ineffective if the AVERAGING function is set to zero.



#### CAUTION

The SENSITIVITY function changes the response characteristics of the magmeter. If used as part of a tuned closed loop control system, such a change may be undesirable.

### No Averaging

With AVERAGING set to zero, the flow rate will be displayed immediately and with no filtering. This line represents the actual output of the flow sensor as it responds to unstable flow conditions in the pipe.

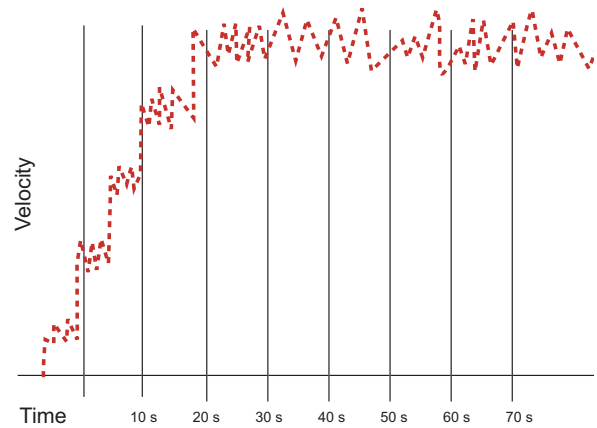

### Averaging Only

With AVERAGING set to 50 seconds and SENSITIVITY still set to zero the flow rate is stabilized, but a sharp change in flow rate is not represented on the display or at the output for 50 seconds or longer.

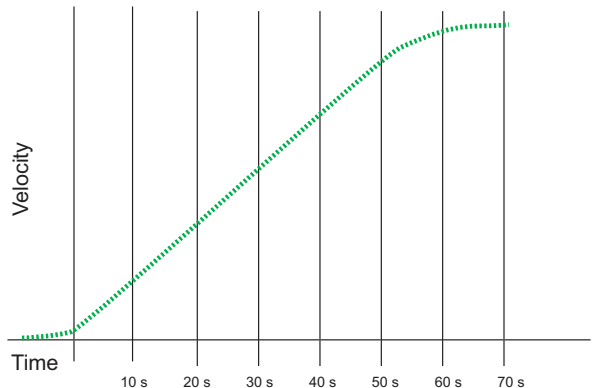

### Averaging and Sensitivity

With AVERAGING at 50 seconds and SENSITIVITY set to 25%, the flow rate is stabilized, while the sudden shift in flow is reflected very quickly.

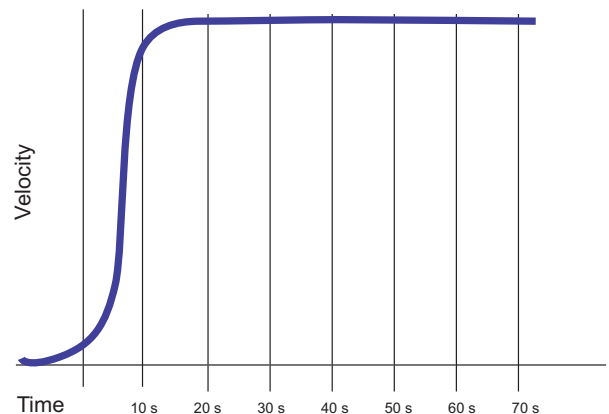

## Bi-Directional Flow

- The 2551 magmeter is designed to measure bi-directional flow.
- The forward flow direction is indicated by the directional arrow molded into the side of the 2551 sensor.
- The conduit ports are assembled at the factory to point UPSTREAM. They may be reversed by disassembling the components of the magmeter and reassembling.

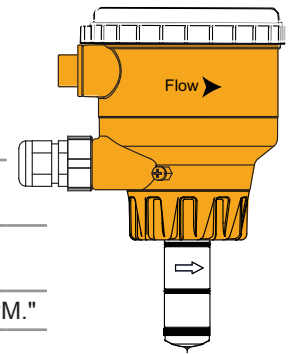

<b>Flow Rate Display</b>	The "+" sign is suppressed during forward flow. "-123.45 GPM" during reverse flow.
<b>Totalizer Display</b>	The totalizer will count during forward flow conditions only. During reverse flow the totalizer will not increment.
<b>Relay Outputs</b>	May be set to detect reverse flow: "Low Setpoint at -25 GPM."
<b>4 to 20 mA output</b>	May be scaled to span any flow range: For example: "4 to 20 mA = -100 GPM to +100 GPM"
<b>Frequency output, Frequency ÷ 10 output</b>	Reverse flow is processed same as forward flow in the frequency output magmeters.
<b>Digital (S<sup>3</sup>L) output</b>	Reverse flow results in 0 flow rate output.

## Calibration Data: K-Factors

### Polypropylene True Union Tees and Wafers PVDF True Union Tees, PVC True Union Tees

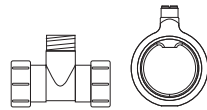

Pipe Size (Metric)	Fitting Type	K-Factor Gallons	K-Factor Liters
<b>POLYPROPYLENE FITTINGS (DIN/ISO, BS, ANSI)</b>			
DN15	PPMT005	2192.73	579.32
DN20	PPMT007	1327.81	350.81
DN25	PPMT010	737.16	194.76
DN32	PPMT012	453.46	119.81
DN40	PPMT015	275.03	72.66
DN50	PPMT020	164.17	43.35
<b>PVDF FITTINGS (DIN/ISO, BS, ANSI)</b>			
DN15	SFMT005	1946.49	514.26
DN20	SFMT007	1158.05	305.96
DN25	SFMT010	749.09	197.91
DN32	SFMT012	439.51	116.12
DN40	SFMT015	248.93	65.77
DN50	SFMT020	146.85	38.80
<b>PVC FITTINGS (DIN/ISO, BS, ANSI)</b>			
DN15	PVMT005	2067.76	546.30
DN20	PVMT007	1136.61	300.29
DN25	PVMT010	716.52	189.31
DN32	PVMT012	446.07	117.85
DN40	PVMT015	278.83	73.67
DN50	PVMT020	159.36	42.10

### PVC Tees and Clamp-on Saddles

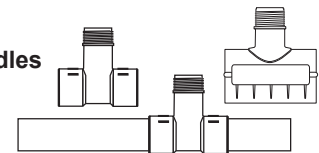

Pipe Size (In.)	Fitting Type	K-Factor Gallons	K-Factor Liters
<b>SCH 80 PVC-U TEES FOR SCH 80 PIPE</b>			
½	MPV8T005	2277.0	601.58
¾	MPV8T007	1407.6	371.90
1	MPV8T010	861.17	227.52
1¼	MPV8T012	464.91	122.83
1½	MPV8T015	331.43	87.56
2	MPV8T020	192.89	50.96
<b>SCH 80 PVC TEES FOR SCH 80 PIPE</b>			
2½	PV8T025	131.46	34.73
3	PV8T030	82.52	21.80
4	PV8T040	44.78	11.83
<b>SCH 80 CPVC TEES FOR SCH 80 PIPE</b>			
½	MCPV8T005	2277.0	601.58
¾	MCPV8T007	1407.6	371.90
1	MCPV8T010	861.17	227.52
1¼	MCPV8T012	464.91	122.83
1½	MCPV8T015	331.43	87.56
2	MCPV8T020	192.89	50.96
<b>SCH 80 PVC CLAMP-ON SADDLES FOR SCH 80 PIPE</b>			
2	PV8S020	193.83	51.21
2½	PV8S025	138.01	36.46
3	PV8S030	83.89	22.16
4	PV8S040	40.88	10.80
6	PV8S060	22.53	5.95
8	PV8S080	12.52	3.31
10	PV8S100	7.94	2.10
12	PV8S120	5.71	1.51
<b>SCH 80 PVC CLAMP-ON SADDLES FOR SCH 40 PIPE</b>			
2	PV8S020	180.01	47.56
2½	PV8S025	123.72	32.69
3	PV8S030	75.81	20.03
4	PV8S040	41.87	11.06
6	PV8S060	19.71	5.21
8	PV8S080	11.73	3.10
10	PV8S100	7.43	1.96
12	PV8S120	5.23	1.38

## Calibration Data: K-Factors

### Carbon Steel Tees and Weld-o-Lets Stainless Steel Tees and Weld-o-Lets Galvanized Iron Tees

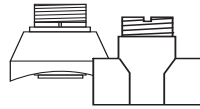

Pipe Size (In.)	Fitting Type	K-Factor Gallons	K-Factor Liters
<b>CARBON STEEL TEES ON SCH 40 PIPE</b>			
½	CS4T005	1572.66	415.50
¾	CS4T007	1086.73	287.11
1	CS4T010	582.34	153.86
1¼	CS4T012	377.48	99.73
1½	CS4T015	267.79	70.75
2	CS4T020	167.85	44.35
<b>STAINLESS STEEL TEES ON SCH 40 PIPE</b>			
½	CR4T005	1601.26	423.05
¾	CR4T007	937.78	247.76
1	CR4T010	606.18	160.15
1¼	CR4T012	279.68	73.89
1½	CR4T015	147.65	39.01
2	CR4T020	111.90	29.56
<b>STAINLESS STEEL WELDOLETS ON SCH 40 PIPE</b>			
2½	CR4W025	106.31	28.09
3	CR4W030	72.27	19.09
4	CR4W040	36.84	9.73
5	CR4W050	29.28	7.73
6	CR4W060	20.29	5.36
8	CR4W080	11.73	3.10
10	CR4W100	7.45	1.97
12	CR4W120	5.24	1.39
<b>CARBON STEEL WELDOLETS ON SCH 40 PIPE</b>			
2½	CS4W025	105.70	27.93
3	CS4W030	70.68	18.67
4	CS4W040	36.38	9.61
5	CS4W050	29.28	7.73
6	CS4W060	20.29	5.36
8	CS4W080	11.73	3.10
10	CS4W100	7.45	1.97
12	CS4W120	5.24	1.39
<b>GALVANIZED IRON TEES ON SCH 40 PIPE</b>			
1	IR4T010	558.50	147.56
1¼	IR4T012	334.45	88.36
1½	IR4T015	248.97	65.78
2	IR4T020	146.00	38.57

### Bronze and Copper Tees and Brazolets

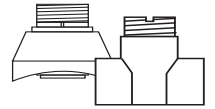

Pipe Size (In.)	Fitting Type	K-Factor Gallons	K-Factor Liters
<b>BRONZE TEES ON SCH 40 PIPE</b>			
1	BR4T010	582.34	153.86
1¼	BR4T012	330.54	87.33
1½	BR4T015	254.76	67.31
2	BR4T020	157.36	41.58
<b>COPPER TEES FITTING ON COPPER PIPE SCH K</b>			
½	CUKT005	2459.19	649.72
¾	CUKT007	1108.02	292.74
1	CUKT010	649.87	171.70
1¼	CUKT012	422.03	111.50
1½	CUKT015	281.43	74.35
2	CUKT020	136.02	35.94
<b>COPPER TEES FITTING ON COPPER PIPE SCH L</b>			
½	CUKT005	2406.30	635.75
¾	CUKT007	1174.77	310.37
1	CUKT010	672.28	177.62
1¼	CUKT012	402.84	106.43
1½	CUKT015	294.99	77.94
2	CUKT020	149.63	39.53
<b>COPPER/BRONZE BRAZOLET ON SCH 40 PIPE</b>			
2½	BR4B025	117.31	30.99
3	BR4B030	78.62	20.77
4	BR4B040	45.13	11.92
5	BR4B050	32.79	8.66
6	BR4B060	22.73	6.01
8	BR4B080	13.14	3.47
10	BR4B100	8.34	2.20
12	BR4B120	5.87	1.55

### Iron Saddles

Pipe Size (In.)	Fitting Type	K-Factor Gallons	K-Factor Liters
<b>SCH 80 IRON SADDLE ON SCH 80 PIPE</b>			
2	IR8S020	194.85	51.48
2½	IR8S025	142.28	37.59
3	IR8S030	87.53	23.13
4	IR8S040	40.62	10.73
5	IR8S050	29.28	7.74
6	IR8S060	22.30	5.89
8	IR8S080	12.52	3.31
10	IR8S100	7.94	2.10
12	IR8S120	5.65	1.49
<b>SCH 80 IRON SADDLE ON SCH 40 PIPE</b>			
2	IR8S020	185.35	48.97
2½	IR8S025	127.47	33.68
3	IR8S030	76.62	20.24
4	IR8S040	40.23	10.63
5	IR8S050	27.32	7.22
6	IR8S060	19.71	5.21
8	IR8S080	11.61	3.07
10	IR8S100	7.36	1.94
12	IR8S120	5.18	1.37

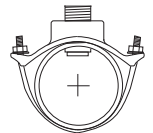

## Calibration Menu

The K-Factors published in this manual assume that the flow conditions in the pipe are ideal.

Many factors that affect the flow rate are beyond the control of the magmeter; variations in actual pipe dimensions, pipe smoothness, and other flow conditions will contribute to the total system error.

Performing a custom calibration with the magmeter in place will adjust the K-Factor and can serve to compensate for installation conditions that may be less than ideal.

Select one of the calibration methods in this menu to achieve the most accurate measurement possible in a specific application.



**NOTE:** The Security Code must be entered before selecting the calibration method.

Enter Code  
0000

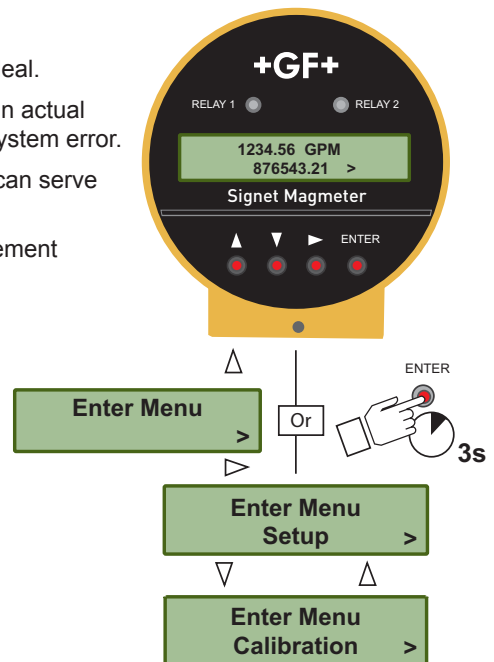

## Volume Method of Calibration

Use the volume method of calibration if the fluid passing the magmeter can be measured by a volumetric method (as in a vessel of known volume, or by weight). It requires the ability to pump a known volume of water past the magmeter, and then input the volume into the 2551 program. It is most useful for small pipes and lower flow rates.

When performed properly, volumetric calibration is the most accurate method. For best results a five minute test period is recommended, and the test period should be no less than two minutes.

Press Enter To Start	At START, the 2551 begins counting the flow past the sensor.
Press Enter To Stop	At STOP, the 2551 stores the total flow accumulated since the START.
Enter Volume 000000. GPM	Enter the VOLUME that has been pumped past the sensor.
Value must be more than 0.0	This error message appears if volume entered or the accumulated flow is zero. Repeat the test after checking the system.
K-Factor Out of Range	This message appears if the new K-Factor is less than 0.0001 or greater than 999999. To correct the problem, perform the volumetric flow again, and be certain that the volume entered is accurate.
K-Factor 45.6789	Using the information from the VOLUME method, the 2551 will recalculate a new K-Factor. Press ENTER to accept the new value, or use the keypad to adjust the value.

## Rate Method of Calibration

Use this method if the 2551 Magmeter must be calibrated to match a reference flow meter. This is the method most commonly used by monitoring agencies, and for large pipes where volumetric calibration is impractical. The accuracy of this calibration method is largely dependent on the accuracy of the reference meter and the proximity of the reference to the Signet 2551 Magmeter.

Set New Flowrate 45.6789	The flow rate shown is based on the existing calibration of the 2551. Use the keypad to modify the flow rate to match the reference meter. The 2551 will automatically calculate a new K-Factor based on the new flow rate.
K-Factor Out of Range	This message appears if the new K-Factor is less than 0.0001 or greater than 999999. To correct the problem, reexamine the flow rate and make certain it is accurate.
K-Factor 56.7890	Using the information from the RATE MATCHING method, the 2551 will recalculate a new K-Factor. Press ENTER to accept the new value, or use the keypad to adjust the value.



## Relay Menus

Magmeter models 3-2551-21 and -22 have two dry contact relays (Relays 1 and 2) and one Solid State relay (Relay 3).

Any of these relays can be set to any of the operating modes listed below.

The setpoint values for HIGH, LOW and WINDOW modes can be set to negative values if required. For example, a LOW alarm might be set to activate if the flow rate falls below -10 GPM.

Negative values are not available for relays in PULSE or TOTAL modes.

**Off:** If a relay is not used, it can be turned Off to prevent contact wear.



**NOTE:** The Security Code must be entered before modifying the relay menu.

Enter Code  
0000

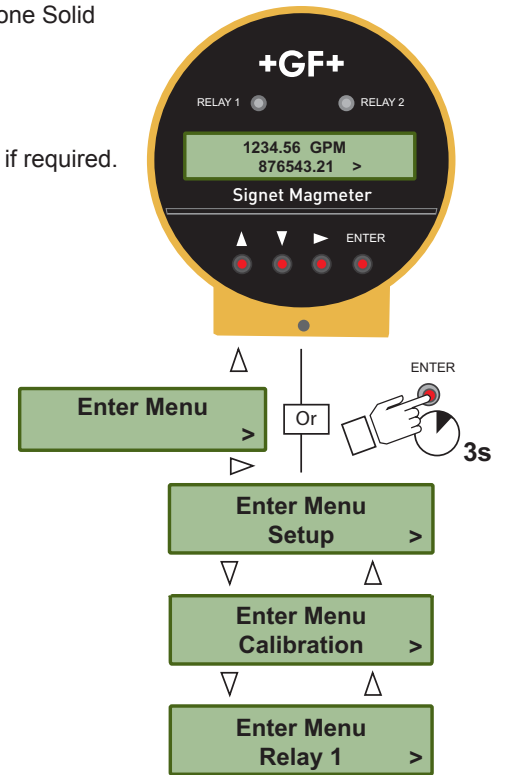

## Pulse Relay Mode

Program a relay to activate for a fixed period, for each volume of fluid that passes the sensor.

For example, program the relay to pulse once for 100 ms for every 3 gallons that pass by the sensor.

Relay 1 Mode  
Pulse >

Relay 1 Volume  
0.0000 Gal >

Relay 1 Width  
0.1 secs >

**Relay Volume:** Set the volume of fluid that the 2551 must measure before activating the relay for one pulse.

**Pulse Width:** Adjust the length of time the relay will remain activated. The pulse width setting is dependent on the type of external equipment being connected to the relay.

## Total Relay Mode

Program a relay to activate when the Resettable totalizer reaches a specific value. The maximum setting is 999999.

Application example: A filter must be replaced in an R.O. system every 10000 gallons. The service representative that installs a new filter sets relay 3 to Total mode, sets the setpoint at 10000 and resets the totalizer to 000000.00. Every time the Totalizer reaches 10000, the relay activates and lights a message indicator to remind the service representative to replace the filter.

When the totalizer is reset, the relay will be deactivated and the process begins anew.

Relay 1 Mode  
Total >

Relay 1 Set High  
000000 >

# High, Low, or Window Relay Modes

Program the relay to activate when the flow rate reaches a setpoint (High or Low) or when the flow rate moves outside of a prescribed range (Window).

## Reverse Flow

The setpoint values for HIGH, LOW and WINDOW modes can be set to negative values if required. For example, a LOW alarm might be set to activate if the flow rate falls to -10 GPM.

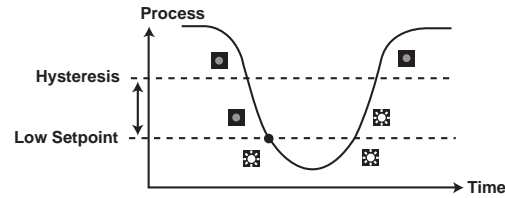

Relay behavior with LOW Setpoint

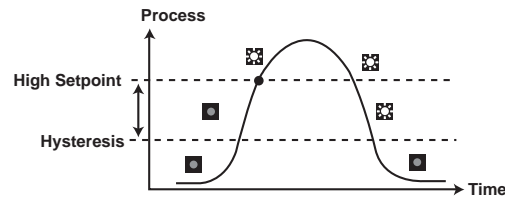

Relay behavior with HIGH Setpoint

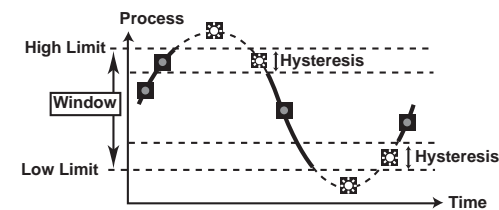

Relay behavior with WINDOW Setpoints

Relay activated   
Relay deactivated 

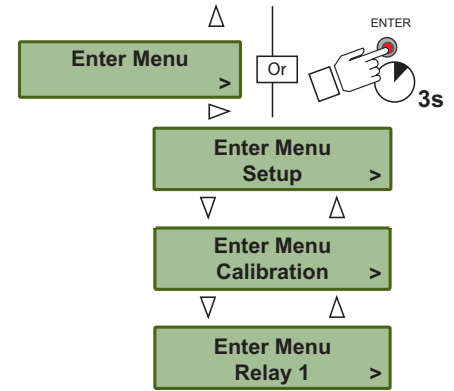
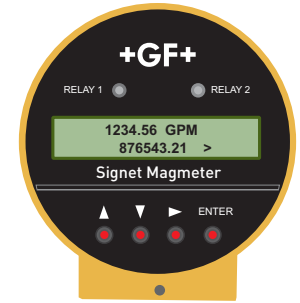

**NOTE:** The Security Code must be entered before modifying the relay menu.

Enter Code  
0000

The values shown for each menu item represent the factory standard setting. All 2551 magmeters are packaged with these settings.

### Set Low:

Set the flow rate where a Low relay will be activated.

### Hysteresis:

Set a flow rate increment where the relay will be deactivated. The hysteresis setting serves to prevent relay "chatter" when the flow rate recovers from an alarm condition by requiring the low rate to move substantially within the setpoint.

### Set High:

Set the flow rate where a High relay will be activated.

### Delay:

Set a time period for the relay to wait after reaching the setpoint. This delay serves to prevent the relay "chatter" by allowing the flow rate time to move back within the setpoint.

Relay 1 Mode Low >	Relay 1 Set Low 00.000 GPM >
	Relay 1 Hys 00.000 GPM >
	Relay 1 Delay 0.1 secs >
Relay 1 Mode High >	Relay 1 Set High 00.000 GPM >
	Relay 1 Hys 00.000 GPM >
	Relay 1 Delay 0.1 secs >
Relay 1 Mode Window >	Relay 1 Set Low 00.000 GPM >
	Relay 1 Set High 00.000 GPM >
	Relay 1 Hys 00.000 GPM >
	Relay 1 Delay 0.1 secs >

The menu repeats for Relay 2 and Relay 3.

## Test Menu

The Test menu provides a simple method to verify that the system is operating properly. Auxiliary power **MUST** be connected to the 2551 to activate the relays

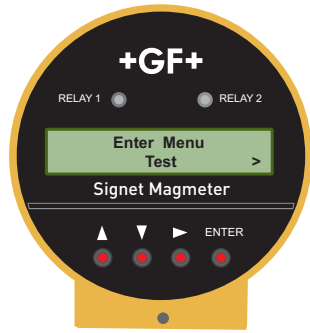

Test Output 4.20 mA >
Test Relay 1 Open Closed >
Test Relay 2 Open Closed >
Test Relay 3 Open Closed >

Shown for 4 to 20 mA models only (3-2551-XX-22, -42). Use the keypad to enter any current output from 4.0 mA minimum to 22.1 mA maximum.

Shown for Relay models Only  
Toggle any of these relays ON and OFF to verify that the system is operating properly.

Auxiliary power **MUST** be connected to the 2551 to test the relays.



## Options Menu

The Options Menu contains those features and settings that will normally be set one time and then seldom changed. These include language preference, decimal placement, Security Code assignment, etc.



Language English >
Security Code **** >
Contrast 2 >
Total Reset Lock On >
Noise Rejection 60 Hz >
Flow Decimal **** ** >
Total Decimal ***** ** >
Separator ddd.d >
Output Mode Frequency >

Select from English, French, German, Italian, Portuguese or Spanish. This selection will be displayed at first power-up of a new magmeter.

Security Code can be set to any four digit number. Factory standard setting is 0000.

Set for best view after the magmeter is installed. Larger number means display appears darker.

Lock ON requires the Security Code before resetting the Resettable Totalizer. Lock OFF reset with no security code.

Filters out common 50 or 60 Hz electrical noise.

Set the maximum resolution for the FLOW RATE display by limiting the decimal to this point. The Flow Rate display will auto-scale from this resolution up to whole units.

Set the maximum resolution for the TOTALIZER display by limiting the decimal to this point. The Totalizer display will always show this resolution.

Select decimal point or comma for use in numeric displays.

For Frequency/Digital models only: Select Freq output, Freq ÷ 10 output, Mirror Relay 1 output or (S<sup>3</sup>L) Digital output.

The values shown for each menu item represent the factory standard setting. All 2551 magmeters are packaged with these settings.

## Output Modes

In **FREQUENCY** output mode, the 2551 serves as a traditional flow sensor and provides an output pulse that is compatible with all Signet POWERED flow instruments. It is not compatible with the 5090 Self-Powered Flow Meter or the 8150-1 Battery-Powered Flow Totalizer. The frequency output range is from 0 Hz to 1000 Hz.

The **FREQUENCY ÷ 10** output mode reduces the output frequency of the 2551 to a range that is useful for some programmable logic controllers (PLC). The frequency output range is from 0 Hz to 100 Hz. This shift does not affect the stated accuracy of the 2551 Magmeter's frequency output.

The **MIRROR RELAY 1** output mode allows 2551 Frequency/Digital models to use the Open Collector Output like a relay that can be programmed via the Relay 1 menu. If the magmeter is equipped with relays, this mode will mirror the settings of Relay 1. If the magmeter is not equipped with relays, this mode can still be selected and programmed via the Relay 1 menu.

The **(S<sup>3</sup>L) Digital** output mode switches the 2551 to the Signet serial data output called (S<sup>3</sup>L) (Signet Serial Sensor Link). In this mode the 2551 can be added to the serial bus of the Signet 8900 Multi-Parameter Controller or 9900 Transmitter.

## Grounding

Pre-calibration conditioning: The magmeter may appear to be unstable immediately after installation. Allow the sensor to sit in a full pipe **for 24 hours** before beginning calibration and operation.

- Use a cable gland or a liquid tight connector to seal the cable ports from water intrusion.
- Use PTFE tape or a suitable sealant on cable ports.
- The 2551 magmeter must be carefully grounded to eliminate electrical noise that may interfere with the measurement.
- Grounding requirements will vary with each installation.
- The following recommendations should be applied in sequence until the interference is eliminated.

- ① The ground terminal on the outside of the yellow housing is connected internally to the grounding ring at the tip of the sensor. Connect a conductor (14 AWG/1.5 mm<sup>2</sup> wire recommended) from this terminal directly to Earth ground to prevent electrical noise from interfering with the magmeter signal.

If the interference persists, apply step #2:

- ② Connect grounding rings, metal clamps or grounding electrodes to the pipe immediately upstream and downstream of the magmeter sensor location. These devices must be in contact with the fluid.

If the interference persists, apply step #3:

- ③ The shield from the output cable must be terminated at the remote instrument ONLY. This shield must not be connected at both ends!

If the interference persists, apply step #4:

- ④ Connect an additional wire (minimum AWG 14/1.5 mm<sup>2</sup>) from the remote instrument ground to the magmeter ground terminal.

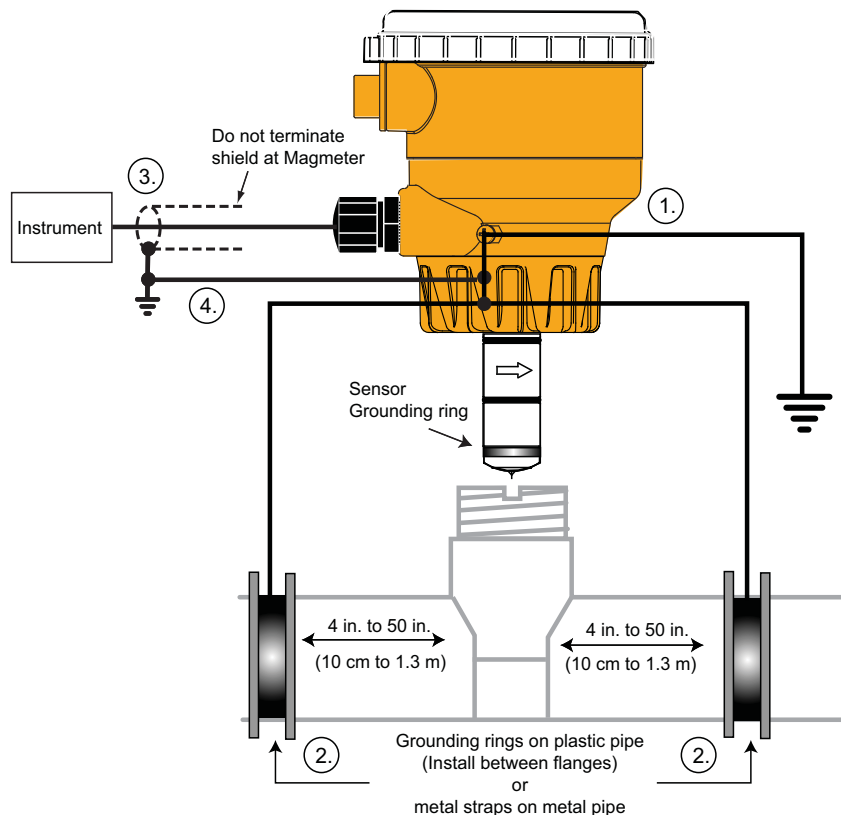

## Maintenance

The 2551 Magmeter requires very little maintenance. There are no user-serviceable components in the magmeter.

- If the fluid contains deposits and solids that may coat the electrodes, a regular cleaning regimen is recommended.
- Do not use abrasive materials on the metal electrodes. Clean with soft cloth and mild detergent only.
- Use a cotton swab and mild detergent to remove deposits on the metal electrodes.

### Environmental Recommendations:

- When used properly, this product presents no inherent danger to the environment.
- Please follow local ordinance when disposing of this or any product with electronic components.

## Troubleshooting

Symptom	Possible Cause	Solution
Output is erratic and unstable.	Magmeter installed too close to upstream obstruction.	Relocate the magmeter to have straight uninterrupted pipe upstream of the sensor for at least 10 x the pipe diameter.
	Magmeter located in area exposed to air bubbles/pockets.	Eliminate air bubbles in the pipe.
	Magmeter is installed in pipe backwards.	Remove the magmeter and reinstall with the flow direction arrow on the sensor body pointed DOWNSTREAM.
	Electrical noise is interfering with the measurement.	Review the grounding of the magmeter and the pipe. Install adequate Earth ground to allow the Magmeter to operate properly.
	Electrodes are coated with deposits or chemical oxide layers.	Carefully clean the electrodes. Refer to sensor manual for details.
Output is not 0 when flow is stopped.	Electrodes not adequately conditioned in fluid.	Allow the sensor to sit in full pipe for 24 hours then restart.
	Fluid is moving inside the pipe.	Increase the Low Flow Cutoff. (page 10)
No 4 to 20 mA output.	Loop power not connected correctly.	Connect 24 VDC $\pm$ 10% connected to loop terminals 1 and 3.
4 to 20 mA current output is incorrect.	4 to 20 mA is not scaled properly.	Check and reset in the Setup Menu.
No Frequency output. No (S <sup>3</sup> L) output.	2551 is wrong model.	Frequency / (S <sup>3</sup> L) model: 3-2551-21 (w/rlys) or -41 (w/o rlys).
	Incorrect setting in Options Menu.	Select Frequency in the Options menu.
	Wiring is not correct.	Check wiring, make corrections.
	Frequency input to other manufacturer's flow instrument does not have pull-up resistor.	Install 10 k $\Omega$ resistor. (page 6)
No flow rate, current output is 22 mA.	The fluid is too clean for Magmeter.	Unsuitable application for Magmeter.
	Electronic component failure.	Return 2551 to factory.
Blank display, no backlighting, no relay LEDs, but external equipment using output signal is still working.	2551 AUX power is not connected.	Connect AUX power (page 7) (9 to 24 VDC, 0.4 A max.)
Error Message: "Error Not Saved"	Main power is below specification.	Correct the main power deficiency.

### Troubleshooting with the RED and BLUE LEDs

- No Lights:** The power is off or the sensor is not connected
- Solid Blue:** The power is on but there is no flow in the pipe.
- Blinking Blue:** Normal operation, blink rate is proportional to the flow rate.
- Alternating Red-Blue:** Empty pipe indication (electrodes are not wet.)
- Blinking Red:** System errors (Electrical noise interference)
- Solid Red:** Instrument error (defective electronic component)

#### Reverse flow:

- Frequency output cannot distinguish reverse flow from forward flow. The output will be the absolute value.
- Digital (S<sup>3</sup>L) output: Reverse flow results in 0 flow rate displayed on 8900, or with negative numbers on the 9900.
- 4 to 20 mA output can be spanned into negative flow range using the 3-0252 Configuration Tool.  
(example: 4 to 20 mA = -100 to +100 GPM).

#### Empty Pipe Detection

- Frequency output will be locked to 0 Hz if electrodes are not wet.
- Digital (S<sup>3</sup>L) output will be locked to 0 if electrodes are not wet.
- 4 to 20 mA will be locked to 4 mA if electrodes are not wet.
- Blue and Red LED indicators on the magmeter circuit will blink alternately if the electrodes are not wet.

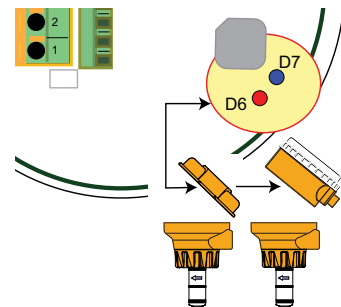

## Ordering Information

### Frequency or Digital (S<sup>3</sup>L) output

Mfr. Part No.	Code	Description
3-2551-P0-21	159 001 267	DN15 to DN100 (½ in. to 4 in.) Polypropylene and 316L SS. Two SPDT relays, one solid state relay
3-2551-T0-21	159 001 436	DN15 to DN100 (½ in. to 4 in.) PVDF and Titanium. Two SPDT relays, one solid state relay
3-2551-V0-21	159 001 269	DN15 to DN100 (½ in. to 4 in.) PVDF and Hastelloy-C. Two SPDT relays, one solid state relay
3-2551-P0-41	159 001 261	DN15 to DN100 (½ in. to 4 in.) Polypropylene and 316L SS.
3-2551-T0-41	159 001 433	DN15 to DN100 (½ in. to 4 in.) PVDF and Titanium
3-2551-V0-41	159 001 263	DN15 to DN100 (½ in. to 4 in.) PVDF and Hastelloy-C
3-2551-P1-21	159 001 268	DN125 to DN200 (5 in. to 8 in.) Polypropylene and 316L SS. Two SPDT relays, one solid state relay
3-2551-T1-21	159 001 437	DN125 to DN200 (5 in. to 8 in.) PVDF and Titanium. Two SPDT relays, one solid state relay
3-2551-V1-21	159 001 270	DN125 to DN200 (5 in. to 8 in.) PVDF and Hastelloy-C. Two SPDT relays, one solid state relay
3-2551-P1-41	159 001 262	DN125 to DN200 (5 in. to 8 in.) Polypropylene and 316L SS
3-2551-T1-41	159 001 434	DN125 to DN200 (5 in. to 8 in.) PVDF and Titanium
3-2551-V1-41	159 001 264	DN125 to DN200 (5 in. to 8 in.) PVDF and Hastelloy-C
3-2551-P2-21	159 001 435	DN250 to DN900 (10 in. to 36 in.) Polypropylene and 316L SS. Two SPDT relays, one solid state relay
3-2551-T2-21	159 001 454	DN250 to DN900 (10 in. to 36 in.) PVDF and Titanium. Two SPDT relays, one solid state relay
3-2551-V2-21	159 001 456	DN250 to DN900 (10 in. to 36 in.) PVDF and Hastelloy-C. Two SPDT relays, one solid state relay
3-2551-P2-41	159 001 432	DN250 to DN900 (10 in. to 36 in.) Polypropylene and 316L SS
3-2551-T2-41	159 001 460	DN250 to DN900 (10 in. to 36 in.) PVDF and Titanium
3-2551-V2-41	159 001 462	DN250 to DN900 (10 in. to 36 in.) PVDF and Hastelloy-C

### 4 to 20 mA output

Mfr. Part No.	Code	Description
3-2551-P0-22	159 001 273	DN15 to DN100 (½ in. to 4 in.) Polypropylene and 316L SS. Two SPDT relays, one solid state relay
3-2551-T0-22	159 001 439	DN15 to DN100 (½ in. to 4 in.) PVDF and Titanium. Two SPDT relays, one solid state relay
3-2551-V0-22	159 001 275	DN15 to DN100 (½ in. to 4 in.) PVDF and Hastelloy-C. Two SPDT relays, one solid state relay
3-2551-P0-42	159 001 279	DN15 to DN100 (½ in. to 4 in.) Polypropylene and 316L SS.
3-2551-T0-42	159 001 442	DN15 to DN100 (½ in. to 4 in.) PVDF and Titanium
3-2551-V0-42	159 001 281	DN15 to DN100 (½ in. to 4 in.) PVDF and Hastelloy-C
3-2551-P1-22	159 001 274	DN125 to DN200 (5 in. to 8 in.) Polypropylene and 316L SS. Two SPDT relays, one solid state relay
3-2551-T1-22	159 001 440	DN125 to DN200 (5 in. to 8 in.) PVDF and Titanium. Two SPDT relays, one solid state relay
3-2551-V1-22	159 001 276	DN125 to DN200 (5 in. to 8 in.) PVDF and Hastelloy-C. Two SPDT relays, one solid state relay
3-2551-P1-42	159 001 280	DN125 to DN200 (5 in. to 8 in.) Polypropylene and 316L SS
3-2551-T1-42	159 001 443	DN125 to DN200 (5 in. to 8 in.) PVDF and Titanium
3-2551-V1-42	159 001 282	DN125 to DN200 (5 in. to 8 in.) PVDF and Hastelloy-C
3-2551-P2-22	159 001 438	DN250 to DN900 (10 in. to 36 in.) Polypropylene and 316L SS. Two SPDT relays, one solid state relay
3-2551-T2-22	159 001 455	DN250 to DN900 (10 in. to 36 in.) PVDF and Titanium. Two SPDT relays, one solid state relay
3-2551-V2-22	159 001 457	DN250 to DN900 (10 in. to 36 in.) PVDF and Hastelloy-C. Two SPDT relays, one solid state relay
3-2551-P2-42	159 001 441	DN250 to DN900 (10 in. to 36 in.) Polypropylene and 316L SS
3-2551-T2-42	159 001 461	DN250 to DN900 (10 in. to 36 in.) PVDF and Titanium
3-2551-V2-42	159 001 463	DN250 to DN900 (10 in. to 36 in.) PVDF and Hastelloy-C

### Replacement Parts and Accessories

1220-0021	198 801 186	O-ring, FPM
1224-0021	198 820 006	O-ring, EPDM
1228-0021	198 820 007	O-ring, FFPM
3-8050.390-1	159 001 702	Retaining Nut Replacement Kit, NPT, Valox®
3-8050.390-3	159 310 116	Retaining Nut Replacement Kit, NPT, PP
3-8050.390-4	159 310 117	Retaining Nut Replacement Kit, NPT, PVDF
3-8050.396	159 000 617	RC Filter kit (for relay protection)
3-8551.521	159 001 378	Clear plastic cap for display



Georg Fischer Signet LLC, 3401 Aero Jet Avenue, El Monte, CA 91731-2882 U.S.A. • Tel. (626) 571-2770 • Fax (626) 573-2057  
For Worldwide Sales and Service, visit our website: [www.gfsignet.com](http://www.gfsignet.com) • Or call (in the U.S.): (800) 854-4090  
For the most up-to-date information, please refer to our website at [www.gfsignet.com](http://www.gfsignet.com)