

Instruction Manual

2290 Non-contact Radar Level Transmitter





Original instruction manual

Follow the instruction manual

The instruction manual is part of the product and is an important element of the safety concept.

- ▶ Read and follow the instruction manual.
- ▶ Always keep the instruction manual available with the product.
- ▶ Pass on the instruction manual to all subsequent users of the product.

Contents

Original instruction manual.....	3
Contents.....	4
1 Intended use	6
2 About this document	6
2.1 Warnings	6
3 Safety and responsibility	6
4 Transport and storage.....	7
5 Design and function.....	7
5.1 Function	7
5.2 Principle of operation	7
6 Technical data.....	9
6.1 Dimensions	10
6.2 Determining the maximum measuring range	11
7 Conditions of safe operation	12
8 Installation	12
8.1 Mounting	12
8.2 Wiring	14
8.2.1 Wiring of the devices	15
8.2.2 Determine the appropriate power supply voltage	16
8.3 Loop current checking with hand instrument	17
9 Programming 2290 Level Transmitter	18
9.1 The display unit.....	18
9.1.1 Information Screens.....	20
9.1.2 Echo Map.....	21
9.2 Programming with the display module	21
9.2.1 Components of the programming interface	21
9.2.2 Menu structure	23
9.3 Programmable features description	23
9.3.1 Basic measurement setting.....	23
9.3.2 Output setup.....	25
9.3.3 Digital output	26
9.3.4 Optimization	26
9.3.5 Calculations	29
9.3.6 Service	32
10 Repair and Maintenance	34

11	Accessories	34
12	Error codes	34
13	2290 W-100 Parameter table	35
14	Menu map	38
15	Removal	41
16	Disposal.....	41

1 Intended use

The GF type 2290 non-contact microwave level transmitters provide the most advanced, new generation measurement technique of the industrial process automation field. The 2290 is an ideal solution for high precision level transmitting of liquids, slurries, emulsions and other chemicals in a wide range of applications, such as food, energy, pharmaceutical and the chemical industry, and even in naval applications with mm accuracy range and high measuring stability.

2290 is able to provide an excellent non-contact level measurement for those substances which tend to steam, or for liquids with a gas layer. Since microwaves do not need a defined propagation media, the 2290 is applicable in a vacuum.

2 About this document

2.1 Warnings

This instruction manual contains warning notices that alert you to the possibility of injuries or damage to property. Always read and pay attention to these warnings!



Risk of fatal or serious injury!

There is a risk of fatal or serious physical injury if warnings are ignored!



Danger of personal injury!

Failure to comply leads to a risk of personal injury!

NOTE

Risk of damage to property!

Failure to comply leads to a risk of damage to property (loss of time, loss of data, device fault etc.)!

3 Safety and responsibility

- ▶ Only use the product for the intended purpose, see Intended Use.
- ▶ Do not use any damaged or faulty product. Sort out any damaged product immediately.
- ▶ Have the product and accessories installed only by persons who have the required training, knowledge or experience.
- ▶ Regularly train personnel on all questions regarding the local regulations applying to occupational safety and environmental protection, especially for pressurized tanks.

4 Transport and storage

- ▶ Protect the product against external forces during transport (impacts, knocks, vibrations etc.).
- ▶ Transport and / or store the product unopened in its original packaging.
- ▶ Protect the product from dust, dirt, moisture as well as heat and ultraviolet radiation.
- ▶ Ensure that the product is not damaged either by mechanical or thermal influences.
- ▶ Before assembling, check the product for damage during transport.

5 Design and function

5.1 Function

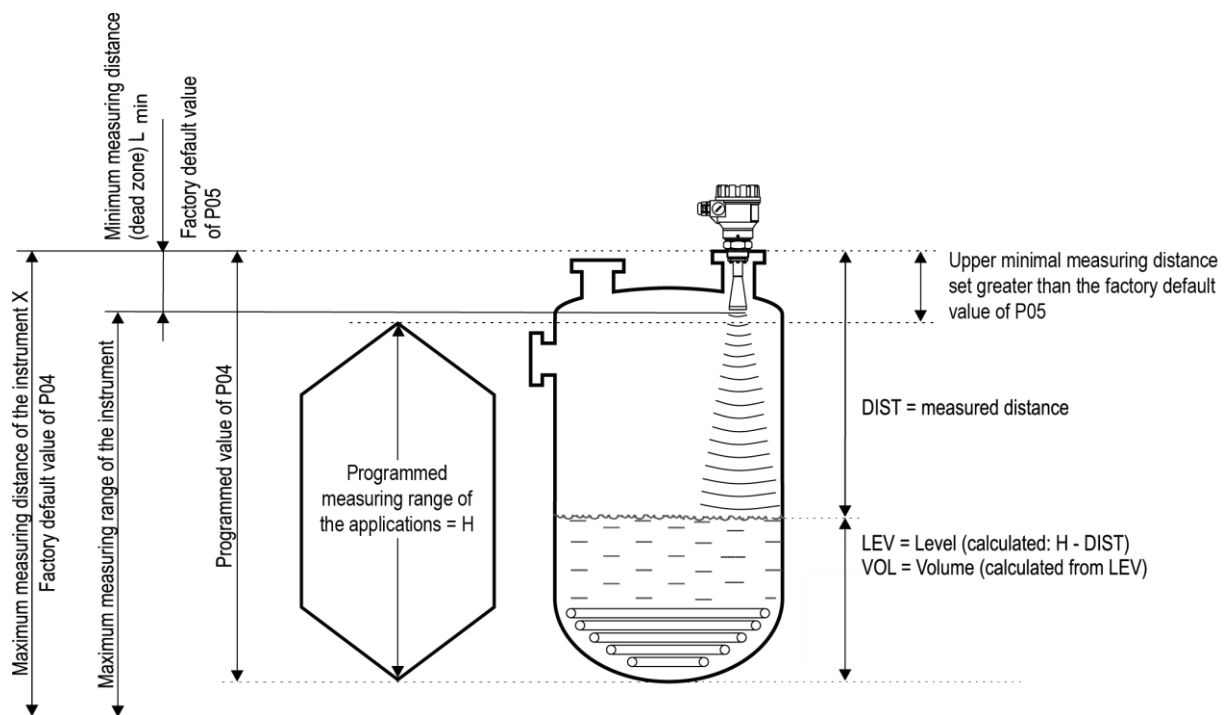

5.2 Principle of operation



The reflection of the emitted microwave varies in quality depending on the relative dielectric constant of the measured medium. The ideal condition of microwave level measurement is that the relative dielectric constant (ϵ_r) for the medium should be greater than 1.9.

The operation of the non-contact microwave level transmitters is based on the measurement of the time of flight of the reflected signals, so-called Time Domain Reflectometry (TDR) method.

The propagation speed of microwave impulses is practically the same in air, gases and in vacuum, independently from the process temperature and pressure, so the measured distance is not affected by the physical parameters of medium to be measured.

The 2290 level transmitter is a Pulse Burst Radar operating at 25 GHz (K-band) microwave frequency.

The 25 GHz models' most noticeable advantage over the lower frequency (5-12 GHz) radars are the smaller antenna size, the better focusing, lower dead-band and smaller transmission angle.

The level transmitter emits nanosecond length impulses from the antenna, and part of the emitted energy reflects back from the measurement surface, the strength of the reflect varies on the medium being measured. The time of flight of the reflected signal is measured and processed by the electronics, and then this is converted to distance, level or volume proportional data.

6 Technical data

Data	Kv value
Measured values	Level, Distance; Calculated values: Volume, Mass
Frequency of the measuring signal	~25 GHz (K-band)
Measuring range	0.2 m – 18 m (0.65 ft – 59 ft) (depending on ϵ_r of the process liquid)
Linearity error (as per EN 61298-2)	< 0.5 m: ± 25 mm (< 1.6 ft: ± 0.9 inch); 0.5 – 1 m: ± 15 mm (1.6 – 3.2 ft: ± 0.6 inch); 1 – 1.5 m: ± 10 mm (3.2 – 4.9 ft: ± 0.4 inch); 1.5 – 8 m: ± 3 mm (4.9 – 26.3 ft: ± 0.1 inch); > 8 m: $\pm 0.04\%$ (> 26.3 ft: $\pm 0.04\%$) of the measured distance
Minimal beam angle	19°
Minimal dielectric constant ϵ_r of the medium	1.9 (refer to range diagram below)
Resolution	1 mm (0.04 inch)
Temperature error (as per EN 61298-3)	0.05% FSK / 10 °C (50 °F); -20 °C... +60 °C (-68 °F... +140 °F)
Power Supply voltage	20 V ...36 V DC
Output	4 – 20 mA + HART
Output Display	64 x 128 Dot Matrix LCD Graphical display unit
Measuring frequency	10...60 sec as per the application settings
Antenna diameter	38 mm (1 1/2")
Antenna material	Horn: Stainless Steel; enclosure options: PP or PTFE
Process Media	-30 °C... +100°C (-22 °C... +212°C), (up to 120 °C (248 °F) for max. 2 min); with PP antenna enclosure: max.: 80 °C (176 °F)
Max. media pressure	25 bar at 120°C (248 °F); with plastic antenna enclosure: 3 bar at 25 °C (77 °F)
Ambient temperature	-20 °C... +60 °C (-4 °F... 140 °F)
Process Connection	DN 40 / 1 1/2" BSP, 1 1/2" NPT" thread
Ingress protection	IP 67
Electrical connection	2x M 20 x 1.5 cable glands + internal thread for 2x 1/2" NPT cable protective pipe, cable outer diameter: $\varnothing 7 \dots \varnothing 13$ mm (0.3 ... 0.5 inch), wire cross section: max. 1.5 mm ² (AWG 15), wire cross section: max. 1.5 mm ²
Electrical protection	Class III
Housing material	Plastic (/PBT)
Sealing	FPM
Communication certifications	R&TTE, FCC
Material of wetted parts	PP / PTFE /Stainless Steel 316 Ti

Explosion Protection, Ex markings, Ex limit data

Type	2290
IECEx (ia)	Ex ia IIB T6...T5 Ga/Gb Li: 200µH Ci: 16nF Ui:30V li:140mA Pi:1W
ATEX (ia)	 II 1/2 G Ex ia IIB T6...T5 Ga/Gb Li: 200µH Ci: 16nF Ui:30V li:140mA Pi:1W

Temperature limit data for hazardous atmospheres:

Temperature data for hazardous gas atmospheres (II B group)	2290	
Maximum permissible medium temperature at the antenna	+80°C (176 °F)	+80°C (176 °F)
Maximum permissible surface temperature at the process connection	+75°C (167 °F)	+80°C (167 °F)
Temperature class	T6	T5

6.1 Dimensions

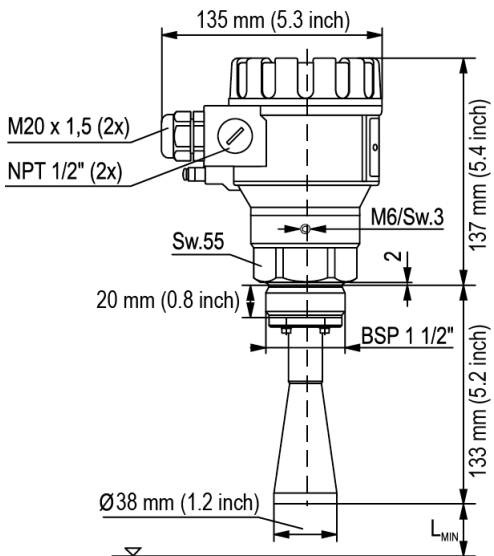
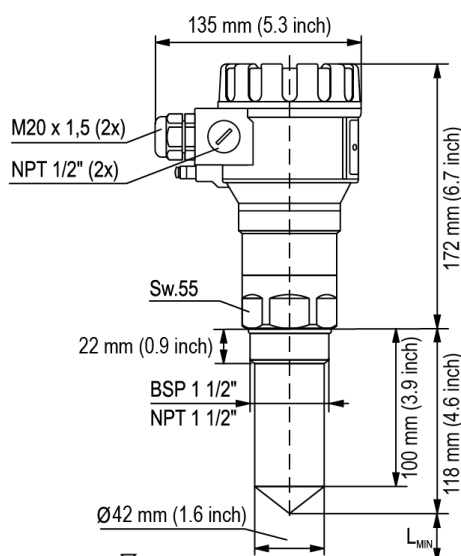
Plastic Housing, 1½" Horn antenna 2290-S-DB2-18+2290-F-ENC-B2/N2 2290-S-DN2-18	Plastic Housing, 1½" PP encapsulated antenna 2290-P-1DB2-18 2290-P-1DN2-18
	
1.4571, antenna, PTFE antenna enclosure	PP
1½" BSP, 1½" NPT	1½" BSP, 1½" NPT
L _{min} : 200 mm (7.9 inch)	L _{min} : 200 mm (7.9 inch)
19°	19°

6.2 Determining the maximum measuring range

The maximum measuring range of the 2290 radar is dependent upon the circumstances of the application environment and on the selected type of antenna enclosure. Depending on the relative dielectric constant of the measuring medium and the process conditions the maximum measurement range (achievable under the reference conditions) may decrease by even 85%.

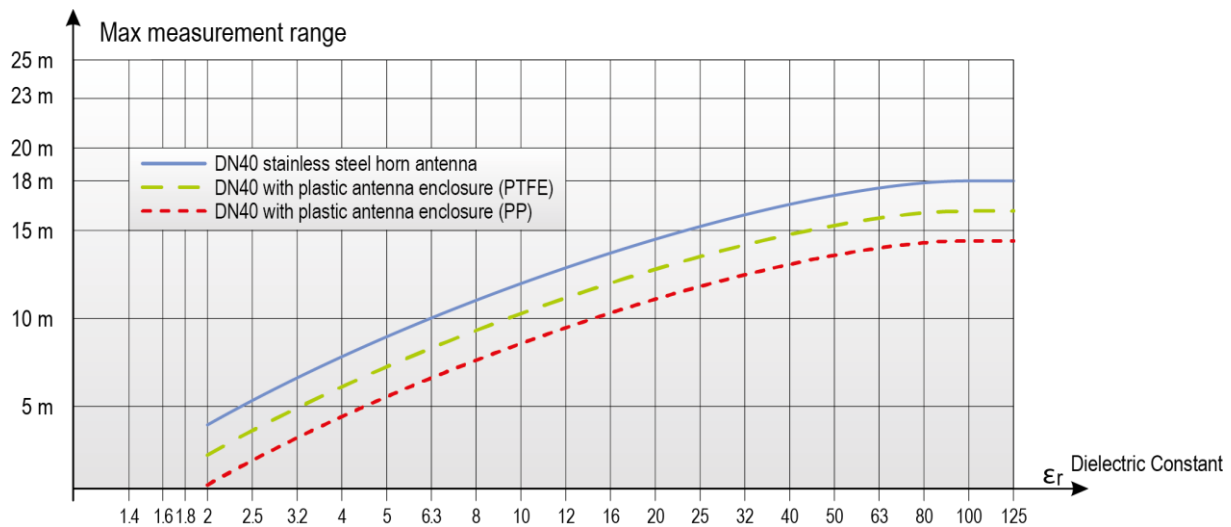

ATTENTION

The maximum measuring distance is illustrated in the above diagram for various Dielectric Constants. This diagram is based upon the following conditions, liquids with still surface, no foam, vapors, and ideally a slow (<5m/h, 16.4 ft/h) rate of level change.

Depending on the process conditions or the plastic antenna enclosure the following typical reducing factors are recommended to be considered in order to calculate the maximum measuring range. When more than one reducing factors occur at the same time then all the factors should be included for the calculation:

Process Condition	Reflection reduction in Amplitude	Max. measuring distance decrease by	Reducing Factor
Slow mixing or slightly waving	2...6 dB	20-50%	0.8...0.5
Foaming	2...6 dB	20-50%	0.8...0.5
Fast mixing, vortex	8...10 dB	60-70% (the measurement might be completely terminated)	0.4...0.3
Vapors, Steam, Condensation	3...10 dB	30-70% (the measurement might be completely terminated)	0.7...0.3
PP antenna enclosure	2 dB	20%	0.8
PTFE antenna enclosure	1 dB	10%	0.9

7 Conditions of safe operation

To avoid the danger of electrostatic charge accumulation, in case of the type 2290 (with plastic electronic housing or plastic antenna enclosure) the following safety rule shall be observed:

- The measured medium should be an electrostatic conductor and the electrical resistivity of the measured medium cannot exceed $10^4 \Omega$.
- The speed and the method of the filling and emptying process should be chosen properly according to the measured medium.
- The plastic antenna enclosure should only be wiped cleaned with a wet cloth.

Meeting the requirements of the technological process

Please carefully consider that all parts of the instrument which can possibly come into contact with the measured medium – including the transducer, the sealing and any other mechanical parts – should meet all requirements of the applied technological process, such as the process pressure, temperature and chemical effects of the used technologies.

FCC Radio license

This device complies with Part 15 of the FCC Rules. Operation is subject to the following two conditions:

- (1) This device may not cause harmful interference, and
- (2) This device must accept any interference received, including interference that may cause undesired operation.

Changes or modifications not expressly approved by the manufacturer could void the warranty and user's authority to operate the equipment.

8 Installation

8.1 Mounting

When choosing the installation place please ensure proper space for accessing the unit for calibration, verification, and or maintenance service.

Placement

The ideal position for the 2290 is on = $(0.3 \dots 0.5) \times R$ (in case of cylindrical tank). It is highly recommended to consider the beam cone of 19° . The distance between the sensor and the tank wall should be at least 200 mm (7.9 inch). If the unit is installed into dome top or spherical tank, unwanted multiple reflections may appear, which can cancel each other and the measuring signal out, this way it can interfere the measurement.

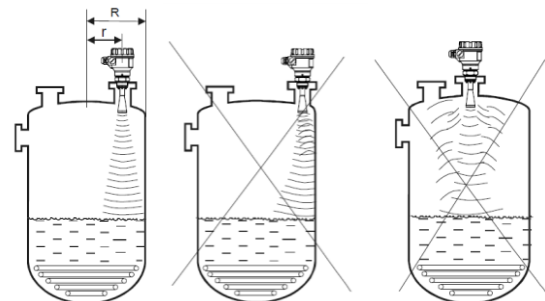

Moving liquid surface

Waving, vortex or strong vibration effects can have negative influence on the measurement accuracy and the maximum measuring range. To avoid these effects, the mounting placement should be as far as possible from the sources of these disturbing effects. According to measurement experiences the maximum measuring distance may decrease by 60-70% when the liquid surface is vortexing. For this reason the device should be mounted as far as possible from the filling stream or the tank outlet.

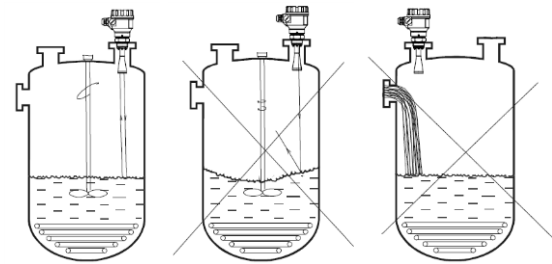

Foaming

Filling, stirring or any other processes in the tank can generate dense foams on the liquid surface, which may considerably damp the reflected signals. According to measurement experiences, in these cases the maximum measuring distance can decrease by as much as 50%.

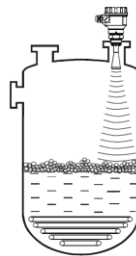

Fumes, Vapours

If the measured medium or its foam can reach the antenna or the measured medium is highly fuming, these cases build-ups can form on the sensor, which may result unreliable level measurement.

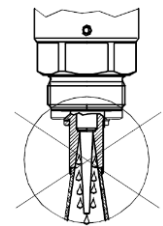

Sensor alignment

The antenna face should be parallel to the medium surface within $\pm 2-3^\circ$.

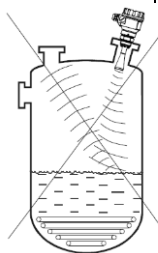

Temperature

To avoid overheating the instrument should be protected against direct sunshine.

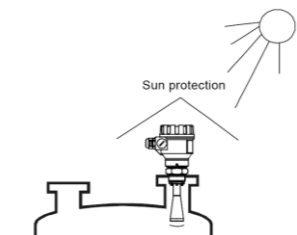

Obstacles

Prior to the installation make sure that no objects (cooling pipes, bracing elements, mixer shaft, other sensors such as pH, Temperature, et cetera) cross the microwave signals. Especially in case of extraordinary large silos bracing elements and other structural obstacles may cause false reflections which can be damped in most cases: a small bent metal deflector plate mounted above the obstacle can disperse the microwave signals and eliminates the false reflections which disturb the reliable measurement.

If there is no possible mechanical solution to avoid these kinds of false reflections, the programming of the instrument allows blocking out the obstacles.

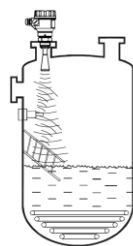

Polarization plane

The emitted radar impulses of 2290 are electromagnetic waves. The orientation of the polarization plane is the same as for the electric wave component of the electromagnetic wave. The rotation of the polarization plane compared to the tank position could be useful (for example to avoid disturbing reflections) in certain applications. To rotate the polarization plane loosen the M6 hex socket set screw above the process connection and rotate the instrument. Then tighten the unit by the screw.

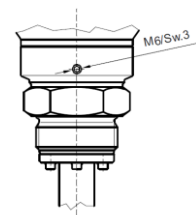

Empty tank

Especially in case of standing tanks with hemispherical bottom and in case of tanks which have any equipment inside at the bottom (e.g. heating element, mixer) wrong level measurement may happen when the tank is totally emptied. The reason for this measurement error is that the tank bottom or the objects at the bottom disperse or reflect the emitted microwave signals. Furthermore these weak and dispersed signals may interfere with Transmitter performance. In order to perform reliable level measurement there should be at least 100 mm liquid level above the disturbing objects at the bottom or above the hemispherical tank bottom.

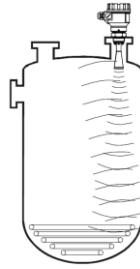

Socket, nozzle



The process connection should be implemented that the antenna end should protrude at least 10 mm out of the socket.

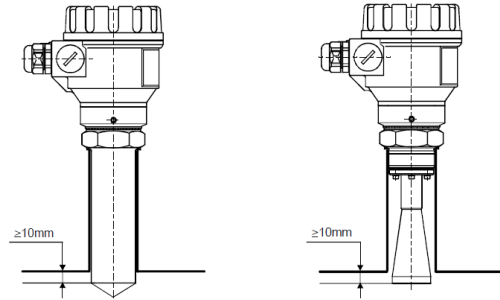

8.2 Wiring

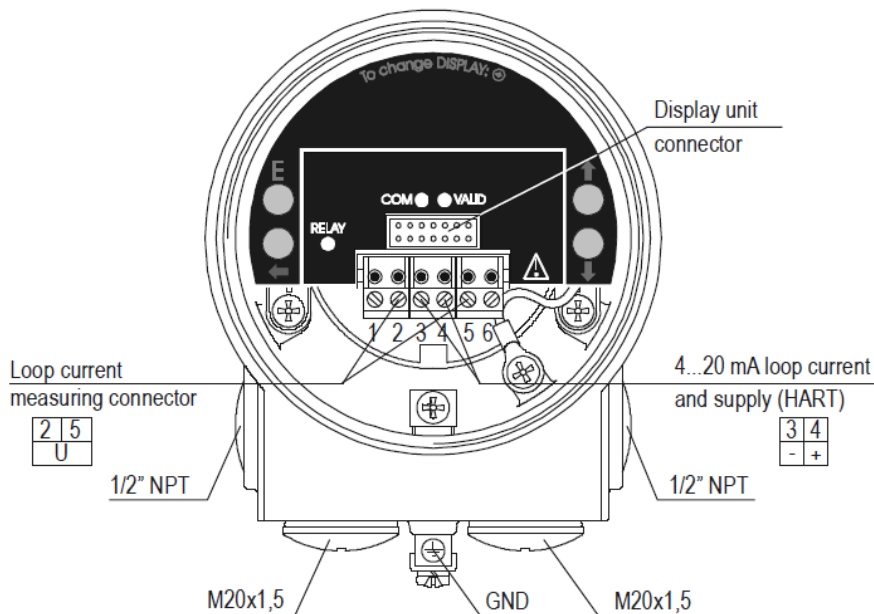

The instrument operates from 20 ... 36 V galvanic isolated and not grounded DC power supply in two-wire system. The voltage value measured on the terminal of the instrument should be minimum 20 V (in case of 4mA)! In case of using HART interface a minimal 250 Ohm resistance should be maintained within the network. The instrument should be wired with shielded cable led through the cable gland. The wiring of the cables can be done after removing the cover of the instrument and the display unit.

NOTE

The grounding screw on the housing of the transmitter should be connected to the equipotential network. Resistance of the EP network should be connected to the system ground with the same potential as the rest of the network. The shield wire of the signal cable should only be grounded at the control panel, and left floating/ insulated at the sensor. To avoid electrical noise, route signal cable away from cables carrying AC voltages. Especially the inductive couplings of AC harmonics can be critical (which are present at frequency converter control) because even cable shielding does not supply effective protection against these cases.

WARNING

The instrument may be damaged by electrostatic discharge (ESD) via its terminal, thus apply the precautions commonly used to avoid electrostatic discharge e.g. By touching a properly grounded point before removing the cover of the enclosure. A possible electrostatic discharge can cause damage for the instrument. Do not touch the internal terminals!

Water / Vapor

To achieve suitable ingress protection GF recommends using the suggested cable outer diameter and properly secure the cable gland.

GF also recommends routing the connecting cables downwards to divert rain water or condensed water away from Transmitter. This is needed in case of outside installations and some special applications where there is very high humidity or the possibility of water condensation is quite high (for example in cleaning, purification processes, in cooled and / or heated tanks).

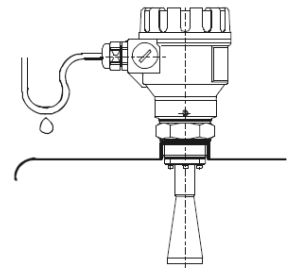

8.2.1 Wiring of the devices

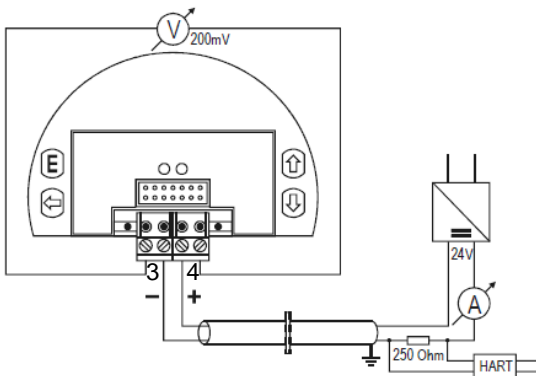

Using HART communication in non-Ex environment

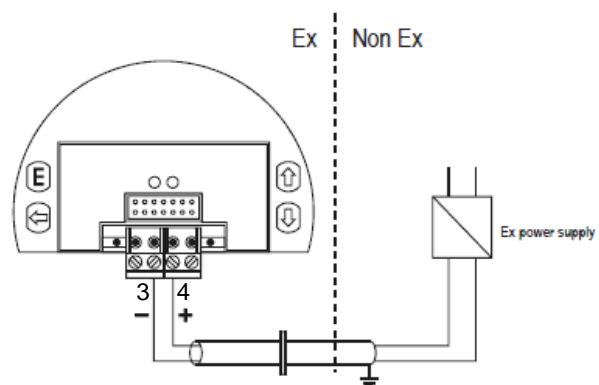

Using Ex approved instrument in hazardous environment

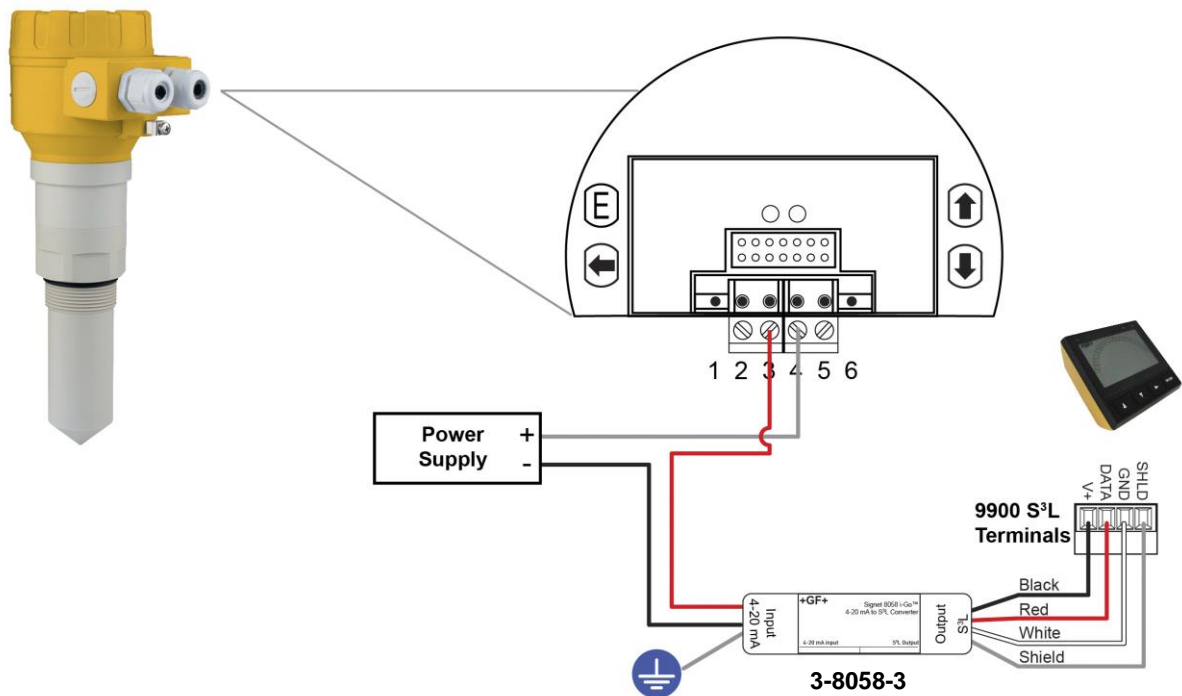

- i-Go converter
- 4...20 mA/S³L
- 159 000 966 wire-mount
- 159 000 967 DIN rail mounted

Connecting a 2290 to a GF Signet 9900 with an i-Go converter.

8.2.2 Determine the appropriate power supply voltage

The minimal power supply voltage required by the 2290 devices is depending on the load impedance in accordance to the below diagram:

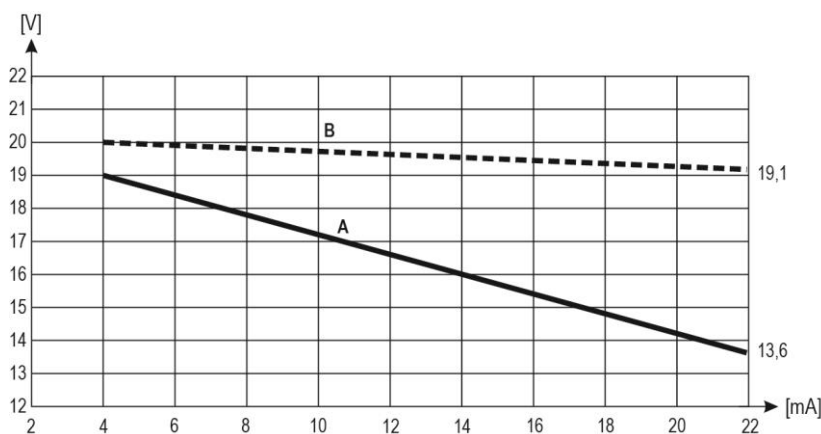

A: Minimal supply voltage on the input terminals of the device

B: minimal supply voltage (considering the voltage drop on the 250 Ohm loop resistor).

Calculation example: Voltage drop calculated with 22 mA:

$$U_{\text{minimal supply voltage [22 mA]}} = 22 \text{ mA} \times \text{load resistance} + U_{\text{input minimum [22 mA]}}$$

$$U_{\text{minimal supply voltage [22 mA]}} = 22 \text{ mA} \times 250 \text{ Ohm} + 9 \text{ V} = 5.5 \text{ V} + 13.6 \text{ V} = 19.1 \text{ V}$$

In order to provide operation in the total current loop range the calculation should be also checked with 4 mA:

$$U_{\text{minimal supply voltage [4 mA]}} = 4 \text{ mA} \times \text{load resistance} + U_{\text{input minimum [4 mA]}}$$

$$U_{\text{minimal supply voltage [4 mA]}} = 4 \text{ mA} \times 250 \text{ Ohm} + 19 \text{ V} = 1 \text{ V} + 19 \text{ V} = 20 \text{ V}$$

Therefore in case of 250 Ohm load resistance 20 V power supply voltage is just enough for the total 4-20 mA measuring range.

8.3 Loop current checking with hand instrument

After removing the cover and the Display Module, the actual loop current can be measured through an internal 1 Ohm shunt resistor by connecting a voltmeter (in the range of 200 mV) to the points 2 and 5 indicated on the wiring drawing above – 10mV ~ 1mA.

9 Programming 2290 Level Transmitter

The 2290 transmitters can be programmed (basically) in the following two ways:

- **Programming with the display unit**
All features of the unit can be accessed and all parameters can be set, such as measurement configuration and optimization, outputs, dimensions for 11 different tank shapes, 99-point linearization.
- **Programming with EView2 PC configuration software**

The 2290 include the display unit.

The 2290 transmitters are fully operational without the display as well, it is only needed for local programming and / or local measurement displaying.

Factory default setting 2290 Level Transmitter

The 2290 level transmitters are factory programmed in the following way:

- Measurement mode: Level (LEV). The displayed value is the measured level.
- The current output and the bargraph on the right are proportional to the measured level.
- 4 mA and 0% are assigned to zero level.
- 20 mA and 100% are assigned to the maximum level.
- Error indication by the current output: holding the last value.
- Level tracking time constant: 15 sec.

The instrument regards the distance (DIST) measured from the antenna end as the basic measurement value. This distance is handled and displayed in one of the selected dimensions: m, cm, mm, feet, or inch. Since the maximum measurement distance is given (entered in P04) the instrument can calculate the actual level (LEV) value. If the proper mechanical dimensions of the mounting to distance between the sealing and the tank bottom – is known, the measured level values can be more accurate by adding this data. The level values calculated that way are the base for volume (VOL) calculation and the 99-point linearization table (VMT) also uses these values as input data.

9.1 The display unit

The display unit is a 64x128 dot-matrix LCD display which can be plugged into the transmitter.



The display module is based on LCD technology, so please make sure it is not exposed to permanent heat or direct sunlight, in order to avoid damage of the display unit. If the instrument cannot be protected against direct sunlight or high temperature that is beyond the standard operating temperature range of the display, please do not leave the display in the instrument.



Measurement Display

Elements of the display:

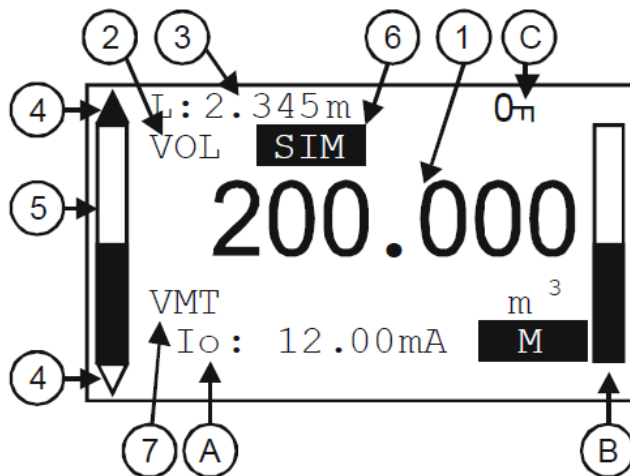

1. Primary (Measured) Value (PV), in accordance to BASIC SETUP / PV. MODE.
2. Calculation mode of Primary Value (PV), in accordance to BASIC SETUP / PV. MODE.
3. Type and value of the initial quantity used for calculating the Primary Value (PV):
 - in case of Level measurement (LEV) it is Distance (DIST),
 - in case of Volume measurement (VOL) it is Level (LEV).
4. Trend direction arrows. The empty triangle shows when the change of the measured value is small, the filled triangle shows large-scale change. If none of the arrows are shown the measured value is constant.
5. Measured PV (Distance Value) in relation to measurement range (Sensor range) displayed in a bargraph.
6. Indication of Primary Value simulation. In this case the display and output show the values of the simulation and not the measured values.
7. Indication of active (Volume / Mass Table - VMT) calculation mode.

During active simulation the critical measurement errors will be displayed to give information to the user.

(A) Calculated value of the output current.

M

Manual mode

H

HART address is not 0, so output current has become overwritten to 4 mA

E!

Analogue transmission reacts to a programmed failure condition if an upper or lower fault current is programmed

(B) Output range (4-20 mA) indicated in a bargraph.

The bottom of the bargraph is assigned to 4 mA and the top is assigned to 20 mA.

C Indication of Menu Lock:

- If key symbol is visible, the unit is protected with a password. When entering the menu, the instrument asks for the correct password.
- If REM message is visible, the instrument is in remote programming mode and the main menu cannot be accessed.

Errors occurred during the measurement can be seen at the bottom line of the display.

9.1.1 Information Screens

Press **↓** button to cycle between the main measurement screen and the information display screen:

1. General information screen (DEV. INFO)
 - Overall running time (OV. RUN TIME)
 - Run time after power on (RUN TIME)
 - Type of interface (INTERFACE) in the instrument.
 - Type of the instrument (TYPE)

Sensor information screen: (SENSOR INFO)

- Number of echoes (ECHO TOT/SEL)
- Position of window (POS. OF WIND)
- Blocking (BLOCKING)
- Signal-to-noise ratio (SN)
- Temperature (TEMP)

2. Echo table: (ECHO TABLE)

- The location (distance) and the amplitude of the echoes (Dist. / Amp.) are listed

The listed items are the reflections detected by the 2290 (measured in dB) and the approximate distance from the process connection. The listed values are not accurate measurement values, since around the selected echo (measurement window) there are further measurements and signal processing procedures in order to provide accurate measurement display and level transmission.

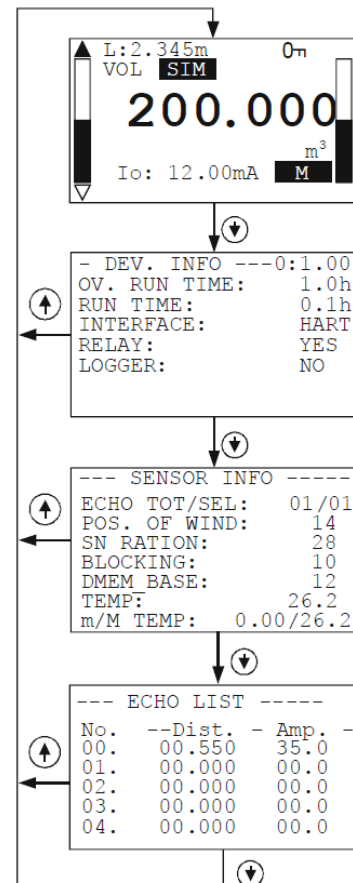



The informative screen returns back to main screen after 30 seconds. By pressing the **↑** button the user can return to the main screen any time. Pressing the **E** button in any of the screens the user can enter the main menu. After exiting the menu always the main screen will be shown.

9.1.2 Echo Map

Pressing the  button in the measurement screen the echo map screen will appear. This screen shows the following information:

1. Echo diagram
2. Actual measured distance
3. Maximum measuring range

The echo map screen returns back to main screen after 30 seconds.

By pressing the  button the user can return to the main screen any time. Pressing the  button in any of the screens the user can enter main menu.

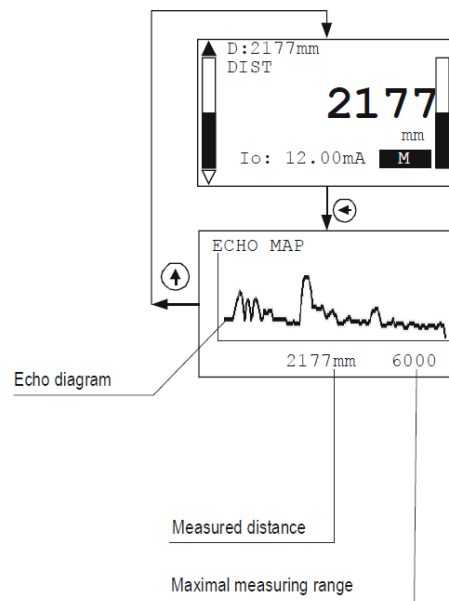

After exiting the menu always the main screen will be shown.



9.2 Programming with the display module

ATTENTION

When entering the menu the instrument makes a copy of the actual parameters and all changes are done to this duplicated parameter set. During programming the instrument keeps measuring and transmitting with the current (and intact) parameter set. After exiting the menu the instrument replaces the original parameters with the new parameter set and will measure according to the new parameters. This means that the change of the parameters does not become immediately effective when pressing the  button!

- Entering the menu can be done by pressing the  button, while exiting the menu can be done by pressing the .
- If the instrument is left in programming mode after 30 minutes it will automatically return to measuring mode. If the display is removed during programming the instrument immediately returns to measuring mode.
- As programming with the display (manual programming) and HART (remote mode) programming is not possible at the same time, only one programming method could be chosen. Measured values can be viewed out through HART at any time.

9.2.1 Components of the programming interface

The parameters of the instrument are grouped according to their functions. The programming interface consists of lists, dialog windows, edit windows and report windows.

Lists

Navigation between the lines of a list can be done by pressing the \uparrow / \downarrow buttons. Pressing the E button activates a list item. The selected list item is marked with inverse colour. Exit from a list by pressing the \leftarrow button.

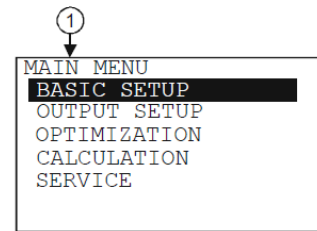

Menu list

The Menu list is a specialized list. Its behavior is that upon selecting a list item we directly get into another list with these lists are opening from the next in different levels.

The menu header (1) helps to navigate.

Entering the main menu can be done by pressing the E button. Navigation between the menu items can be done by pressing the \uparrow / \downarrow buttons. Enter to the selected menu by pressing the E button. The selected list item is marked with inverse colour.

Exit from a submenu by pressing the \leftarrow button. Pressing the \leftarrow button in the main menu will quit from the programming mode and the instrument will return to measuring mode.

Dialog window

During the programming the system sends messages or warnings to the users by dialog windows. These usually can be acknowledged by pressing the \leftarrow button or the user can choose between two options (usually YES or NO) by pressing the \leftarrow / \downarrow buttons. In some cases one of the parameters has to be changed to correct an error.

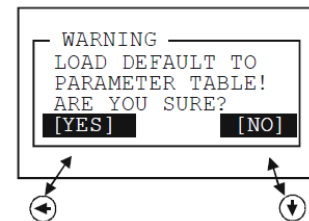

Edit window

An edit window is used for modifying a numeric parameter value. The selected character can be changed by pressing the \uparrow / \downarrow buttons. The cursor can be moved to left, by pressing the \leftarrow button.

The direction of the cursor movement through the digits is right to left. The changed value can be validated by pressing the E button. The software checks if the entered value is appropriate, exiting from the edit window is only possible after entering a correct value. If the entered value is uninterpretable the software sends an error message in the bottom line (1) of the display.

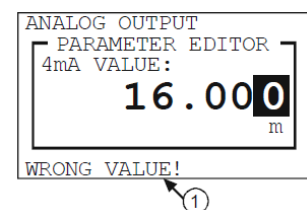

Edit window – button combinations

In the edit window the following button combinations are available:

1. Recalling the parameters to the state before editing
(+, pressed at same time for 3 sec.)
2. Recalling default parameters (+, pressed for 3 sec.)
3. Inserting (currently) measured value to the edit window (+, pressed at same time for 3 sec.) Only for certain parameters!

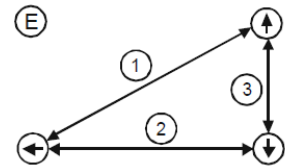

9.2.2 Menu structure

Main Menu

BASIC SETUP	Parameter group of the basic measurement parameters
OUTPUT SETUP	Parameter group of the output parameters
OPTIMIZATION	Parameter group for measurement optimization settings
CALCULATION	Calculations
SERVICE	Service functions, calibration, test and simulation

9.3 Programmable features description

9.3.1 Basic measurement setting

Default unit system

Parameter: P00: c, where c: 0, 1.

Path: BASIC SETUP / UNITS / ENGINEERING SYSTEM

Description: This should be configured as the first step of the programming.

Here you can choose the default unit system:

- EU European unit system
- US American unit system

Default value: EU

Dimensions of the default unit system

Parameter: P00:b, and P02:b, or P02:c

Path: BASIC SETUP / UNITS / ENGINEERING UNITS

Description: The dimension of the selected default unit system can be specified in this menu. The selected measurement mode here will define the primary measured value and the displayed value, furthermore it will be the source for the current output:

- BASIC UNITS (m, cm, mm, ft, inch)
- VOLUME / FLOW UNITS (m3, l, ft3, gallon)
- MASS UNITS (t, t)

If the dimension is modified, the device resets all the parameters after a warning message.

Default value: mm, m3, t

Primary value mode

Parameter: P01: b a

Path: BASIC SETUP / PV MODE

Description: This mode determines the primary value and the displayed value. It also determines the value which will be proportional to the output current.

- DISTANCE
- LEVEL
- VOLUME
- MASS

Default value: DIST

Maximum measuring distance

Parameter: P04

Path: BASIC SETUP / MAX. MEAS.DIST

Description: This parameter should be entered in all cases, except distance measurement mode.

Damping time

Parameter: P20

Path: BASIC SETUP / DAMPING TIME

Description: Damping time is used to damp the unwanted fluctuations of the output and display. If the measured value changes rapidly the new value will settle with 1% accuracy after this set time. [Damping is according to the exponential function].

Default value: 15 sec

Demo mode

Parameter: P00: d

Path: BASIC SETUP / DEMO MODE

Description:

- OFF: The operation is performed with considering all the application parameters (such as filling, emptying speed, echo selection, etc..)
- ON: This fast operation mode ignores the application parameters. The demo mode uses a fast algorithm evaluation independently from P25, P26 and P27 parameters. The measurement accuracy and reliable operation between process environments are not guaranteed!

For demo / presentation purposes only

Default value: OFF

9.3.2 Output setup

Output current mode

Parameter: P12:b, where b: 0, 1.

Path: OUTPUT SETUP / ANALOG OUTPUT / CURRENT MODE

Description: Transmission mode of the current output.

- AUTO The output current is calculated from the measured value, output is active. → Normal operation
- MANUAL The output current is fixed at a constant (set) value. In this mode the setting of the error current is irrelevant. The set (current) value overwrites the 4 mA output of HART multidrop mode!
→ Validation

Default value: AUTO

Output current value assigned to 4 mA

Parameter: P10

Path: OUTPUT SETUP / ANALOG OUTPUT / 4mA VALUE

Description: Measured value assigned to 4 mA current value.

The transmitted value is in accordance to the primary value (PV) (P01:a). Assignment can be such that the change in measured value and the change in the output value are the same (normal), or opposite directional (inverse operation). For example: 1m level is 4 mA, 10m level is 20 mA, or 1m level is 20 mA and 10m level is 4 mA.

Default value: 0 mm

Output current value assigned to 20 mA

Parameter: P11 Path: OUTPUT SETUP / ANALOG OUTPUT / 20mA VALUE

Description: Measured value assigned to 20 mA current value.

The transmitted value is in accordance to the primary value (PV) (P01: a). Assignment can be done that the change in measured value and the change in the output value are the same (normal), or opposite directional (inverse operation). For example: 1m level is 4 mA, 10m level is 20 mA, or 1m level is 20 mA and 10m level is 4 mA.

Default value: Maximum measurement range (mm)

Output current error mode

Parameter: P12:a, a: 0, 1, 2

Path: OUTPUT SETUP / ANALOG OUTPUT / ERROR MODE

Description: Error indication by the current output:

- HOLD Error indication has no effect on the output current.
- 3.8mA Error indication: the output current goes to 3.8mA.
- 22mA Error indication: the output current goes to 22mA.



This error indication is active unless the failure is fixed, or until the failure terminates.

Default value: HOLD

Fixed output current

Parameter: P08

Path: OUTPUT SETUP / ANALOG OUTPUT / MANUAL VALUE

Description: Parameter for setting the fixed output current:

Values between 3.8 and 20.5 can be entered. The output current will be set to the entered value and analog transmission will be suspended. This error indication overrides all other error indication.

Default value: 4 mA

9.3.3 Digital output**Hart polling address**

Parameter: P19

Path: OUTPUT SETUP / SERIAL OUTPUT / ADDRESS

Description: HART Polling Address

The polling address can be set between 0 and 15. For a single instrument the polling address is 0 and the output is 4-20 mA (analog output). If multiple units are used in HART Multidrop mode (max. 15 pcs.) the polling addresses should differ from 0 (1-15), in this case the output current will be fixed at 4 mA.

Default value: 0

9.3.4 Optimization**Blocking, Minimal measuring distance**

Parameter: P05

Path: OPTIMIZATION / DEAD ZONE

Description: The instrument ignores all reflections within the Minimal measuring distance and the close-end blocking distance. The disturbing objects and false reflections which are close to the sensor can be eliminated by entering the minimal measuring distance value manually.

Default value: 300 mm (11.8 inch)

Echo selection

Parameter: P25:a, where a: 0, 1, 2, 3

Path: OPTIMIZATION / ECHO SELECTION

Description: Selection of Echo within the measuring window. In order to avoid disturbing reflections the instrument forms a so-called measuring window around the reflected signal. The distance measurement is performed with the echo signal within the measurement window.

- AUTO
- FIRST
- HIGHEST AMPLITUDE
- LAST

Default value: AUTO

Emptying speed

Parameter: P27

Path: OPTIMIZATION / EMPTYING SPEED

Description: This parameter provides additional protection against echo loss in applications involving very heavy fuming during emptying process. Correct setting increases the reliability of the measurement during the emptying. The parameter must not be smaller than the fastest possible emptying rate of the actual process.

Default value: 50 m/h (0.03 mph)

Filling Speed

Parameter: P26

Path: OPTIMIZATION / FILLING SPEED

Description: This parameter provides additional protection against echo loss in applications involving very heavy fuming during filling process. Correct setting increases the reliability of the measurement during the filling. The parameter must not be smaller than the fastest possible filling rate of the actual technology.

Default value: 50 m/h (0.03 mph)

Background Image / Mapping function

Parameter: OPTIMIZATION / BACKG.ECHO IMAGE / SAVE BACKG. IMAGE

Path: The stationary disturbing objects inside the tank which generates unwanted false reflections can be blocked out from the measurement range. For this purpose the instrument needs to map the totally empty tank to create a "background image". After this procedure the software will automatically recognizes and ignores the reflections coming from the disturbing objects crossing the microwave beam.

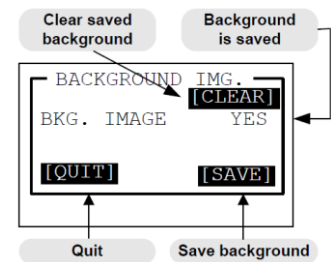

Warning! The background image should be saved only when the tank does not contain measurement medium, but the disturbing objects inside the tank are not removed. The background image is not recommended to be saved when the tank is filled with the measurement medium since it might result wrong level measurement.

Using saved background image

Parameter: P35: a, where a: 0, 1

Path: OPTIMIZATION / BACKG.ECHO IMAGE / SAVE BACKG: IMAGE

Description: Turning ON or OFF the usage of saved background image during the calculations as per the above 5.3.4.5 point described.

- OFF: Ignoring the saved background image.
- ON: Saving background image, damping reflections coming from the disturbing objects.

Default value: OFF

Threshold value

Parameter: P29

Path: OPTIMIZATION / TRESHOLD VALUE

Description: Defining an upper limit value above the saved background image described in point "Background Image / Mapping function". The instrument will evaluate the measurement result as a real echo when the reflected signal exceeds the saved background level with the threshold value entered here. Setting the threshold value is useful when the level in the tank and the position of the (small surface) not-moving disturbing object are the same. This case the instrument will not process the echo signal as false reflection.

Default value: 4 dB

9.3.5 Calculations

Specific gravity

Parameter: P32

Path: CALCULATION / SPECIFIC GRAVITY

Description: Entering a value (other than "0") of specific gravity in this parameter, the MASS value will be displayed instead of Volume (VOL) in the dimension of tonne or lb/tonne depending on P00 (c) and P02 (b).

Default value: 0

Volume / mass calculation mode

Parameter: P47: a

Path: CALCULATION / V/M CALC. MODE

Description: Calculation of the volume and mass can be performed in two ways:

- TANK FUNCTION/SHAPE – volume and mass calculation with a tank shape formula. Entering this menu point the table is automatically OFF.
- V/M TABLE – volume and mass calculation with a table. Entering this menu point the table automatically turns ON.

Default value: 0

Volume / mass table

Parameter: -

Path: CALCULATION / V/M CALC. MODE / V/M TABLE

Description:

- VIEW/EDIT TABLE
- ADD ITEM
- DELETE ITEM

If none of the formulas match perfectly to the characteristics of the needed tank, there is a possibility to use the table calculation mode. The device can handle a 99-point table for this reason and counts values between the neighbouring point pairs with linear interpolation.

The input (left) side of the table contains the level data, the output (right) side contains the volume or mass data.

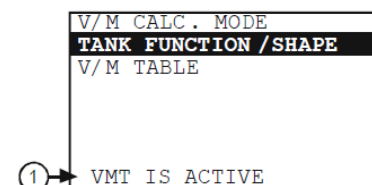

! ATTENTION

The first point pair of the table should be 0,0. If a long table needed to be shortened, 0,0 point pair should be entered into the last item of the table and the device modifies the unused point pairs automatically in the background to 0,0. The status (ON or OFF) of the table is shown on a warning message (1) on the bottom line of the display.

All modifications are done on a temporary table. This temporary table becomes valid after exiting. Modifications during the programming procedure have no effect on the measurement and the transmitting.

Entering the point pairs can be done in arbitrary order, because the device sorts according to ascending order. Both sides of the table have to be strictly monotonic increasing. In case of any errors, warning message will appear. When entering again in the table an inscription indicates the first wrong line.

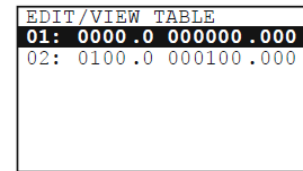

View table:

In VIEW/EDIT TABLE menu point items of the ordered table can be checked. For moving in the list use the \downarrow and \uparrow buttons, for editing the selected item use the E button. Exiting from the list can be done by pressing the \leftarrow button.

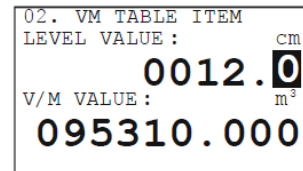

Edit table:

Adding a point pair (ADD ITEM) to the list or pressing E button on an existing item, an edit screen will appear. In this edit screen there are two editing fields. Both editing fields work the same as editing a parameter. Getting from the first field to the second field press the E button. Pressing E button in the second field will return back to the previous menu point. When exiting from the last field, the device performs the ordering of the table.

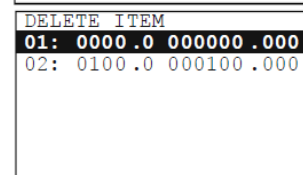

Delete item

Moving in the list can be done with \downarrow and \uparrow buttons, for deleting an item press the E button on the selected item. Exiting from the list can be done by pressing the \leftarrow button. The table should contain at least 2 items.

Tank functions / shape

Parameter: P40:a, where a: 0,1, 2, 3, 4.

Path: CALCULATION / V/M CALC. MODE / TANK FUNCTION/SHAPE

- Description: 0 STANDING CYL. - Standing cylindrical tank
- 1 STD. CYL. CON. BOT. - Standing cylindrical tank with conical bottom
- 2 STD. RECT. W/CHUTE - Standing rectangular tank with or without chute
- 3 LYING CYLINDRICAL - Lying cylindrical tank
- 4 SPHERICAL - Spherical tank

Default value: 0

Tank bottom shape

Parameter: P40:b, where b: 0,1, 2, 3

Path: CALCULATION / V/M CALC. MODE / TANK FUNCTION/SHAPE

Description: This menu only appears, if it has an importance on the selected tank shape type!

- 0 SHAPE 2 SHAPE
- 1 SHAPE 3 SHAPE

Default value: 0

Tank dimensions

Parameter: P41- P45

Path: CALCULATION / V/M CALC. MODE / TANK FUNCTION/SHAPE

- Description:
- DIM1 (P41)
 - DIM2 (P42)
 - DIM3 (P43)
 - DIM4 (P44)
 - DIM5 (P45)

Default value: 0

Standing cylindrical tank with hemispherical bottom a = 0

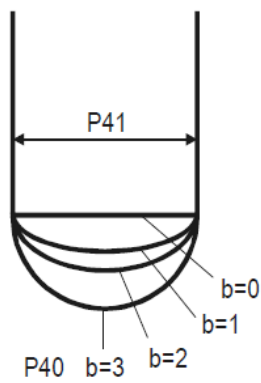

Standing cylindrical tank with conical bottom a = 1 ; b = 0

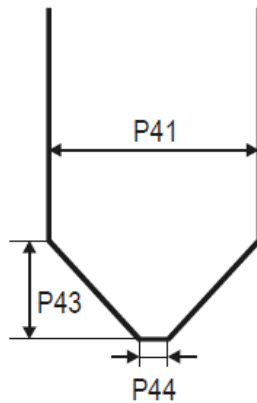

Standing rectangular tank with or without chute a = 2 ; b = 1

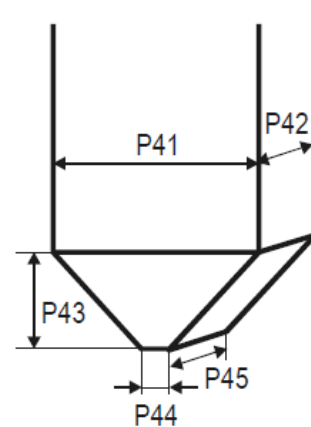

If no chute: P43, P44 and P45 = 0

Lying cylindrical tank a = 3

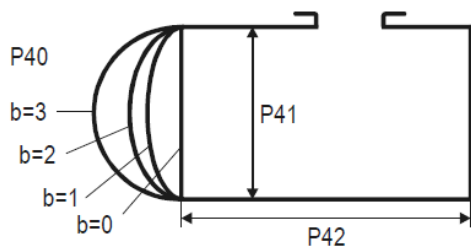

Spherical tank a = 4 ; b = 0

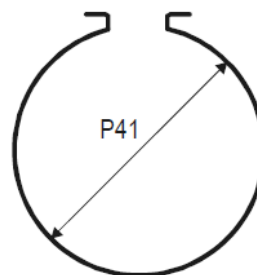

9.3.6 Service

Security codes

User codes

Path: SERVICE / SECURITY / USER LOCK

Description: Setting or unlocking the user security code.

The instrument can be protected against unauthorized programming with a 4 digit PIN (Personal Identification Number) code. If either of the digits differs from 0 the code is active. If zero is specified, then the secret code has been deleted! In case of Active code, this code is requested at menu entry.

Service code

Path: SERVICE / SECURITY / SERVICE LOCK

Description: Setting of the service code.

Only for trained personnel!

Contact GF Piping Systems for more information.

Current output test

Parameter: P80

Path: SERVICE / OUTPUT TEST / ANALOG OUTPUT / CURRENT VALUE

Description: Loop current test (mA)

Entering this Parameter the current value which is proportional to the actual measurement value will appear on the display and the output. In loop current test mode, values between 3.9 and 20.5 can be entered. The output current will be set to the entered value. The measured current on the output should be equal to the set value.

In test mode a dialog window warns the user of the fixed output current until the user exits the warning message window.

Exiting can be done by pressing the $\text{\textcircled{E}}$ button.

Distance simulation

This function facilitates the user to be able to check the calculations (tank formula, table), outputs, and the additional processing instruments connected to the output. 2290 transmitters can perform simulation on the value of a constant or a variable. To start simulation the instrument must return to Measurement mode. In Measurement mode if simulation is in progress, an inverse SIM caption appears on the display.

Simulation mode

Parameter: P84:a, where a: 0,1, 2, 3, 4

Path: SERVICE / DIST SIMULATION / MODE

Description: Simulation mode:

OFF No simulation

FIX VALUE Value of the simulated distance is set according to the lowest value of the simulation.

MANUAL VALUE

TRIANGLE WAVE Value of the simulated distance changes linearly between the lowest and highest values with an adjustable cycle time.

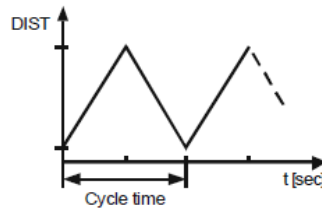

SQUARE WAVE The simulated value jumps between the lowest and highest values with an adjustable cycle time.

Default value: OFF

Simulation cycle

Parameter: P85

Path: SERVICE / DIST. SIMULATION / TIME

Description: Cycle time of the simulation

Default value: 60 sec

Bottom value of the simulation

Parameter: P86

Path: SERVICE / DIST. SIMULATION / BOTTOM VALUE

Description: Lowest value of the simulation

Default value: 0 mm

Upper value of the simulation

Parameter: P87

Path: SERVICE / SIMULATION / UPPER VALUE

Description: Highest value of the simulation

Default value: Programmed measurement range

Load default values

Path: SERVICE / DEFAULTS / LOAD DEFAULT

Description: This command loads all default values of the instrument. After loading the default values the parameters can freely be changed, the effect of the changes does not effect on the measurement until the user exits from the Programming mode and returns to Measurement mode. Before loading the defaults the software asks for a confirmation from the user because all user parameters will be lost!

10 Repair and Maintenance

The 2290 does not require maintenance on a regular basis.

Repairs during or after the warranty period are carried out exclusively at the Manufacturer. The equipment sent back for repairs should be cleaned or neutralized (decontaminated) by the User!

11 Accessories

- User's and Programming Manual
- Declaration of Conformity
- 2 pcs M20x1.5 cable glands

12 Error codes

Message on the screen	Error description	Procedure to do	Code
MEMORY ERROR	Memory error	Contact GF Piping Systems	1
NO ECHO	Sensor error	Contact GF Piping Systems	2
EE COM. ERROR	Hardware error (EEPROM communication error)	Contact GF Piping Systems	3
MATH. OVERLOAD	Calculation overflow	Contact GF Piping Systems	4
SIGNAL IN N.D.B.	Sensor or calibration error (Measured value is in the close-end dead-zone)	Contact GF Piping Systems	5
SIGNAL IN F.D.B.	Sensor or calibration error (Measured value is in the far-blocking zone)	Check the installation conditions!	7
VMT SIZE ERROR	Linearization error: Less than two items are in the table.	Check the content of the VMT!	12
VMT INPUT ERROR	Linearization table error: monotonicity error in the input (level) side of the table.	Check the content of the VMT!	13
VMT OUTPUT ERROR	Linearization table error: monotonicity error in the output (volume or mass) side of the table.	Check the content of the VMT!	14
VMT INPUT OV.RNG.	Linearization table error: The measured level is greater than the highest level of the table's input side.	Check the content of the VMT! Device performs extrapolation according to the last point pairs!	15
EE CHK ERROR	Parameter checksum error.	Check the programming! For recalculate the checksum	16

Message on the screen	Error description	Procedure to do	Code
		modify a parameter and return to Measurement mode. If this error still remains, contact the GF service!	
INTEGRITY ERROR	Parameter integrity error (Automatically corrected internal error). Only WARNING message.	Check the programming!	17
AC COM. ERROR	Hardware error	Contact GF Piping Systems	18
CALIBRATION ERROR	Sensor calibration error	Contact GF Piping Systems	19

13 2290 W-100 Parameter table

Pxx	Parameter name	d	c	b	a
00	Engineering system, dimensions	DEMO mode : 0 = Normal mode 1 = Demo mode	Engineering system: 0 = EU 1 = US	Dimension: (EU) 0 = m, 1 = cm, 2 = mm (US) 0 = ft, 1 = inch	
01	Source of Primary Value (PV)				0 = DIST, 1 = LEVEL, 2 = VOLUME, 3 = MASS
02	Selectable dimensions		Time units: 0 = sec 1 = min 2 = hour 3 = day	VOL/F-EU) 0 = m ³ , 1=liter (VOL/F-US) 0 = ft ³ , 1 = US gallon (MASS-EU) 0 = tonne, 1= US tonne (MASS-US) 0 = tonne, 1 = lb(pound)	
04	Max. measuring distance	Maximum measuring distance of the level transmitter can be defined			
05	Blocking / DEAD ZONE	Minimal measuring distance within the ignores all the measurement Values			

Pxx	Parameter name	d	c	b	a
08	Fix current output	Fix forced value on the output current between 3.8 and 20.5 mA for loop current measuring purposes (operation mode = manual)			
10	4 mA	Measured and transmitted value (PV) assigned to 4 mA current value			
11	20 mA	Measured and transmitted value (PV) assigned to 20 mA current value			
12	Output current mode			Operation mode: 0 = AUTO 1 = MANUAL	Error indication of the current output: 0 = HOLD 1 = 3,5 mA 2 = 22 mA
19	HART polling address	HART Short Address of the level transmitter (0-15)			
20	Damping time	Damping time of the accurate transmitted (displayed) value in sec. after a high fluctuation in the measured value (0-999)			
25	Echo selection in the measuring window				0 = AUTO 1 = FIRST 2 = HIGHEST AMPLITUDE 3 = LAST
26	Filling speed	Rate of change of the measured value (when distance is decreasing) which can be just followed with the level transmitter			
27	Emptying speed	Rate of change of the measured value (when distance is increasing) which can be just followed with the level transmitter			
29	Threshold value	Threshold limit value (0 - 6 dB) for the received echo evaluation			
32	Specific gravity of the medium	Data for mass calculation			
35	Background mode				Calculating with the saved background image: 0 = OFF 1 = ON
40	Tank shape				0 = Standing cylindrical tank with dome bottom 1 = Standing cylindrical tank with conical bottom 2 = Standing rectangular tank with or without chute 3 = Lying cylindrical tank 4 = Spherical tank
41-45	Tank dimensions				
47	VMT mode				Operation of the linearization 0 = OFF 1 = ON
60	Overall runtime	Elapsed overall operating hours of the level transmitter (working time) with 0.1 hour accuracy. Service data			

Pxx	Parameter name	d	c	b	a
61	Runtime after last reset	Elapsed operating hours of the level transmitter since the last turning ON with 0.1 hour accuracy. Service data			
70	Number of echoes	Service data			
71	Position of the measuring window	Service data			
74	Signal-to-noise ratio	Service data			
75	Blocking distance value	Service data			
80	Current output test	Fix forced value on the output current between 3.8 and 20.5 mA for checking the accuracy of the current generator			
84	Simulation				Distance simulation mode: 0 = No simulation 1 = Fix value 2 = Simulation with a manual value: PV=a entered in P86 3 = Simulation between P86 and P87 levels with P85 cycle time (triangle wave) 4 = Simulation between P86 and P87 levels with P85 cycle time (square wave)
85	Cycle time of DIST simulation	Cycle time of the distance simulation in seconds. Default value: 60 sec			
86	Bottom value of the simulation	Initial value of the distance simulation in the selected unit (e.g.: mm). Default value: 0 (mm)			
87	Upper value of the simulation	Final value of the distance simulation in the selected unit (e.g.: mm). Its default value is the same as the programmed maximum measurement range.			

14 Menu map

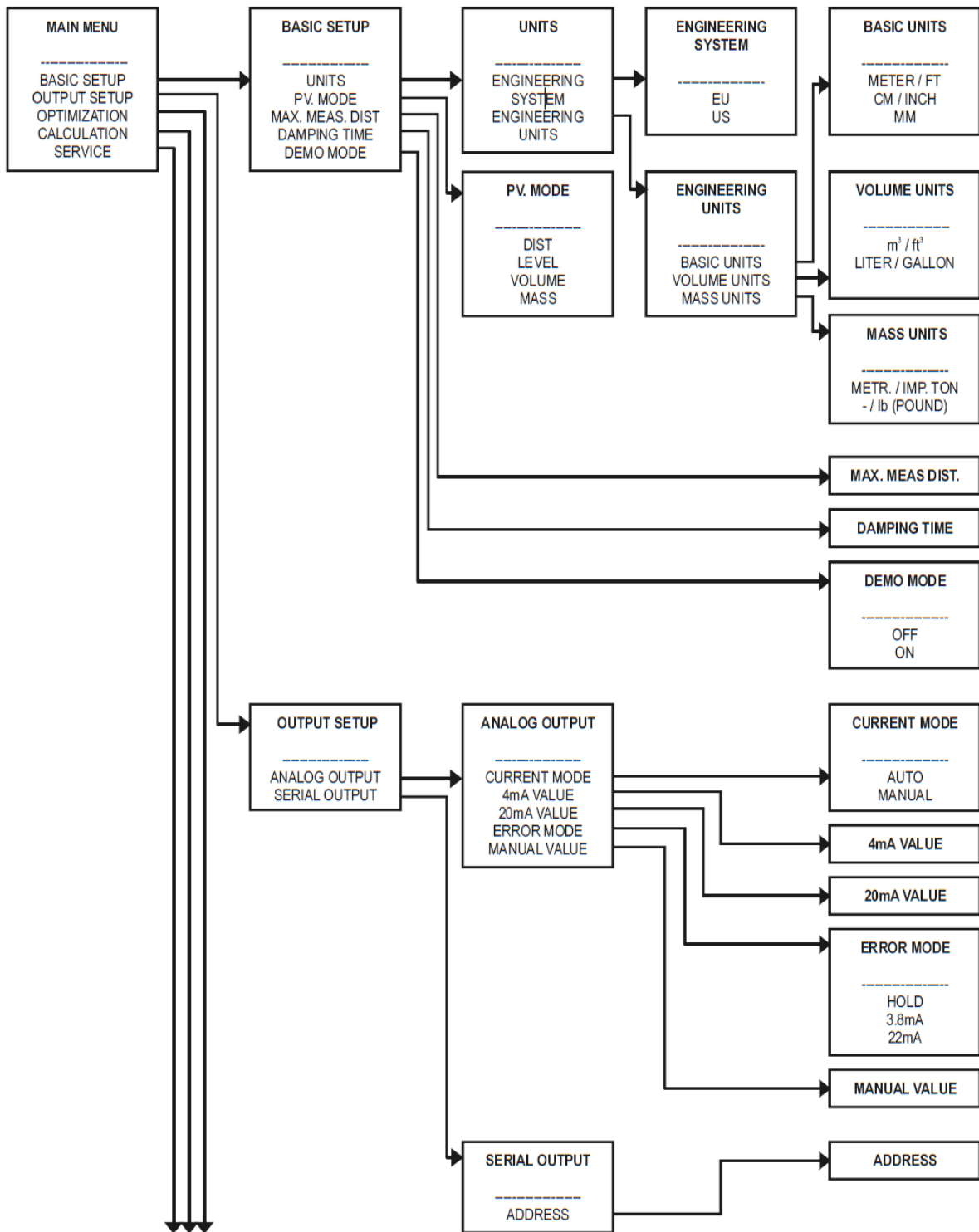

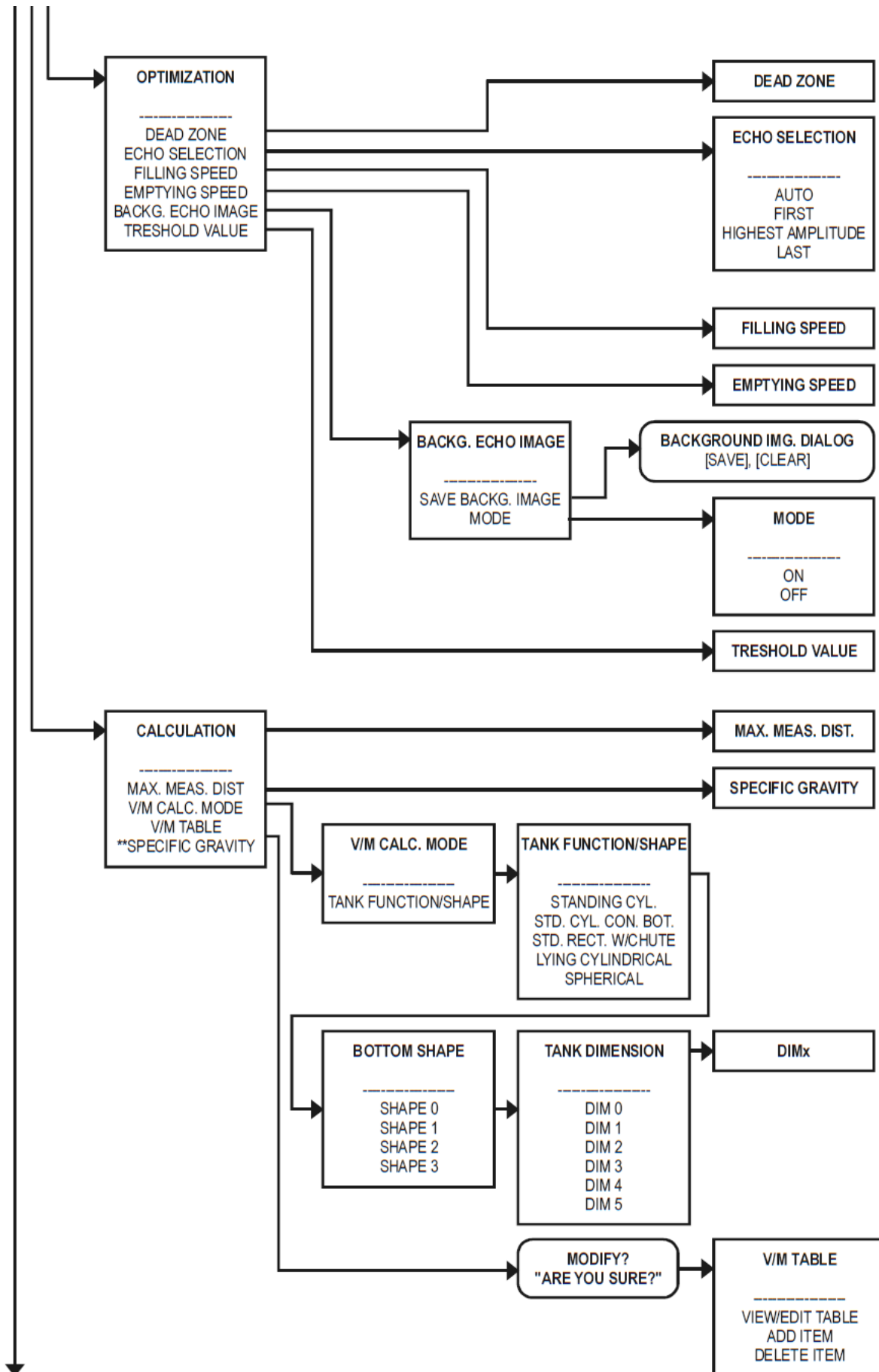

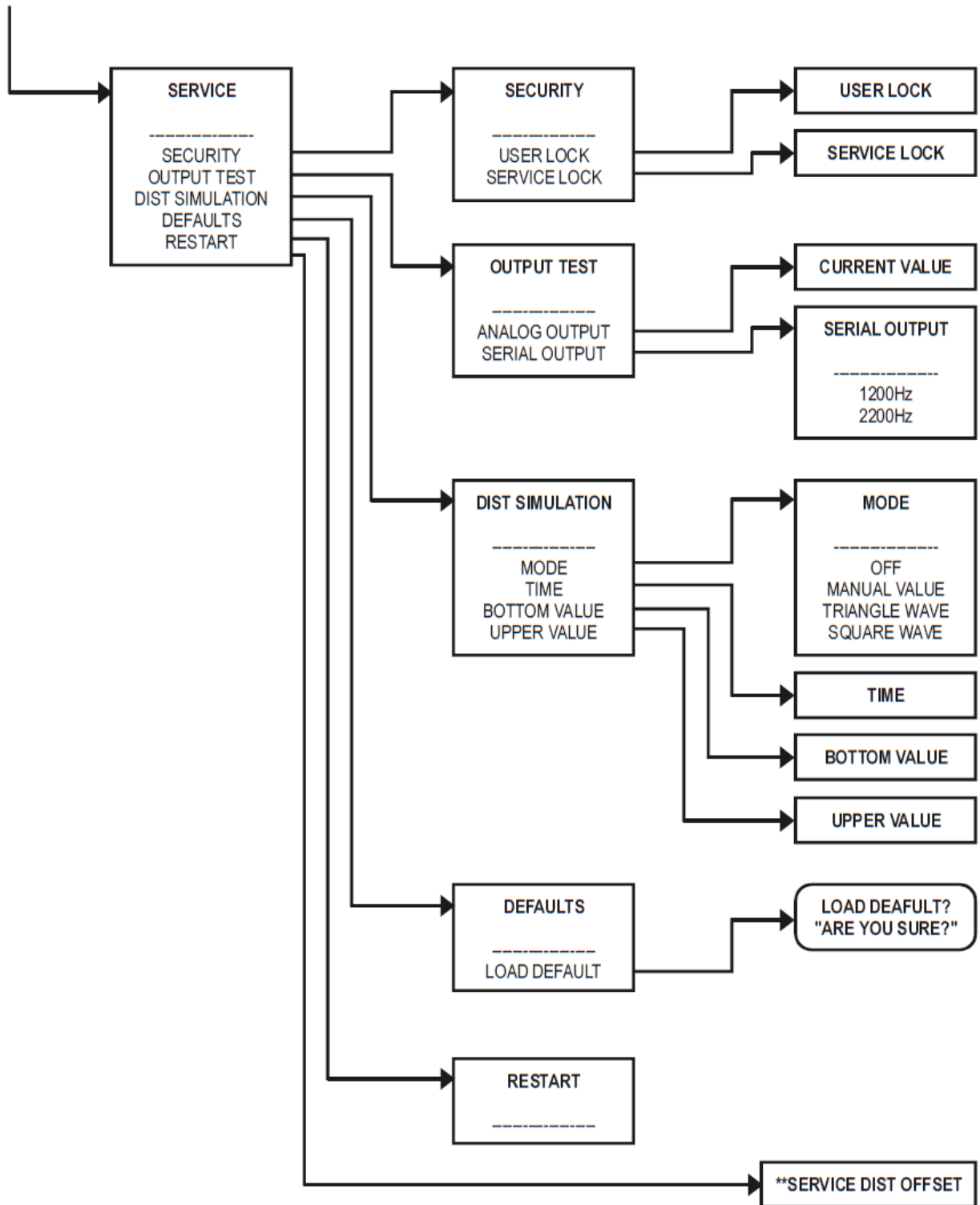

15 Removal

- ▶ Switch off the external power supply and prevent it from being switched on again.
- ▶ Disconnect all cable connections.

16 Disposal

- ▶ Before disposing of the different materials, separate them into recyclable materials, normal waste and special waste.
- ▶ Comply with local legal regulations and provisions when recycling or disposing of the product, individual components and packaging.
- ▶ Comply with national regulations, standards and directives.



A product marked with this symbol must be taken to a separate collection point for electrical and electronic devices.

If you have any questions regarding disposal of the product, please contact your national agent for GF Piping Systems.

Worldwide at home

Our sales companies and representatives ensure local customer support in over 100 countries

www.gfps.com

Argentina / Southern South America

Georg Fischer Central Plastics
Sudamérica S.R.L.
Buenos Aires, Argentina
Phone +54 11 4512 02 90
gfcentral.ps.ar@georgfischer.com
www.gfps.com/ar

Australia

George Fischer Pty Ltd
Riverwood NSW 2210 Australia
Phone +61 (0) 2 9502 8000
australia.ps@georgfischer.com
www.gfps.com/au

Austria

Georg Fischer
Rohrleitungssysteme GmbH
3130 Herzogenburg
Phone +43 (0) 2782 856 43-0
austria.ps@georgfischer.com
www.gfps.com/at

Belgium / Luxembourg

Georg Fischer NV/SA
1070 Bruxelles/Brüssel
Phone +32 (0) 2 556 40 20
be.ps@georgfischer.com
www.gfps.com/be

Brazil

Georg Fischer Sist. de Tub. Ltda.
04571-020 São Paulo/SP
Phone +55 (0)11 5525 1311
br.ps@georgfischer.com
www.gfps.com/br

Canada

Georg Fischer Piping Systems Ltd
Mississauga, ON L5T 2B2
Phone +1 (905) 670 8005
Fax +1 (905) 670 8513
ca.ps@georgfischer.com
www.gfps.com/ca

China

Georg Fischer Piping Systems Ltd
Shanghai 201319
Phone +86 21 3899 3899
china.ps@georgfischer.com
www.gfps.com/cn

Denmark / Iceland

Georg Fischer A/S
2630 Taastrup
Phone +45 (0) 70 22 19 75
info.dk.ps@georgfischer.com
www.gfps.com/dk

Finland

Georg Fischer AB
01510 VANTAA
Phone +358 (0) 9 586 58 25
Fax +358 (0) 9 586 58 29
info.fi.ps@georgfischer.com
www.gfps.com/fi

France

Georg Fischer SAS
95932 Roissy Charles de Gaulle Cedex
Phone +33 (0) 1 41 84 68 84
fr.ps@georgfischer.com
www.gfps.com/fr

Germany

Georg Fischer GmbH
73095 Albershausen
Phone +49 (0) 7161 302-0
info.de.ps@georgfischer.com
www.gfps.com/de

India

Georg Fischer Piping Systems Ltd
400 083 Mumbai
Phone +91 224007 2001
branchoffice@georgfischer.com
www.gfps.com/in

Indonesia

George Fischer Pte Ltd –
Representative Office
Phone +62 21 2900 8564
Fax +62 21 2900 8566
sgp.ps@georgfischer.com
www.gfps.com/sg

Italy

Georg Fischer S.p.A.
20063 Cernusco S/N (MI)
Phone +39 02 921 861
it.ps@georgfischer.com
www.gfps.com/it

Japan

Georg Fischer Ltd
556-0011 Osaka,
Phone +81 (0) 6 6635 2691
jp.ps@georgfischer.com
www.gfps.com/jp

Korea

GF Piping Systems
Georg Fischer Korea Co., Ltd.
Unit 2501, U-Tower
120 HeungdeokJungang-ro (Yeongdeok-dong)
Giheung-gu, Yongin-si, Gyeonggi-do, Korea
Phone: +82 31 8017 1450
Fax: +82 31 217 1454
kor.ps@georgfischer.com
www.gfps.com/kr

Malaysia

Georg Fischer (M) Sdn. Bhd.
40460 Shah Alam, Selangor Darul Ehsan
Phone +60 (0) 3 5122 5585
Fax +603 5122 5575
my.ps@georgfischer.com
www.gfps.com/my

Mexico / Northern Latin America

Georg Fischer S.A. de C.V.
Apodaca, Nuevo Leon
CP66636 Mexico
Phone +52 (81) 1340 8586
Fax +52 (81) 1522 8906
mx.ps@georgfischer.com
www.gfps.com/mx

Middle East

Georg Fischer
Piping Systems (Switzerland) Ltd
Dubai, United Arab Emirates
Phone +971 4 289 49 60
gcc.ps@georgfischer.com
www.gfps.com/int

Netherlands

Georg Fischer N.V.
8161 PA Epe
Phone +31 (0) 578 678 222
nl.ps@georgfischer.com
www.gfps.com/nl

Norway

Georg Fischer AS
1351 Rud
Phone +47 67 18 29 00
no.ps@georgfischer.com
www.gfps.com/no

Philippines

Georg Fischer Pte Ltd
Representative Office
Phone +632 571 2365
Fax +632 571 2368
sgp.ps@georgfischer.com
www.gfps.com/sg

Poland

Georg Fischer Sp. z o.o.
05-090 Sekocin Nowy
Phone +48 (0) 22 31 31 0 50
poland.ps@georgfischer.com
www.gfps.com/pl

Romania

Georg Fischer
Piping Systems (Switzerland) Ltd
020257 Bucharest - Sector 2
Phone +40 (0) 21 230 53 80
ro.ps@georgfischer.com
www.gfps.com/int

Russia

Georg Fischer
Piping Systems (Switzerland) Ltd
Moscow 125040
Phone +7 495 748 11 44
ru.ps@georgfischer.com
www.gfps.com/ru

Singapore

George Fischer Pte Ltd
11 Tampines Street 92, #04-01/07
528 872 Singapore
Phone +65 6747 0611
Fax +65 6747 0577
sgp.ps@georgfischer.com
www.gfps.com/sg

Spain / Portugal

Georg Fischer S.A.
28046 Madrid
Phone +34 (0) 91 781 98 90
es.ps@georgfischer.com
www.gfps.com/es

Sweden

Georg Fischer AB
117 43 Stockholm
Phone +46 (0) 8 506 775 00
info.se.ps@georgfischer.com
www.gfps.com/se

Switzerland

Georg Fischer
Rohrleitungssysteme (Schweiz) AG
8201 Schaffhausen
Phone +41 (0) 52 631 30 26
ch.ps@georgfischer.com
www.gfps.com/ch

Taiwan

Georg Fischer Co., Ltd
San Chung Dist., New Taipei City
Phone +886 2 8512 2822
Fax +886 2 8512 2823
www.gfps.com/tw

United Kingdom / Ireland

Georg Fischer Sales Limited
Coventry, CV2 2ST
Phone +44 (0) 2476 535 535
uk.ps@georgfischer.com
www.gfps.com/uk

USA / Caribbean

Georg Fischer LLC
9271 Jeronimo Road
92618 Irvine, CA
Phone +1 714 731 88 00
Fax +1 714 731 62 01
us.ps@georgfischer.com
www.gfps.com/us

International

Georg Fischer
Piping Systems (Switzerland) Ltd
8201 Schaffhausen/Switzerland
Phone +41 (0) 52 631 30 03
Fax +41 (0) 52 631 28 93
info.export@georgfischer.com
www.gfps.com/int

The technical data are not binding. They neither constitute expressly warranted characteristics nor guaranteed properties nor a guaranteed durability. They are subject to modification. Our General Terms of Sale apply.